

DO NOT SCALE UNLESS STATED - IF IN DOUBT ASK

Material	
Qty Req'd	

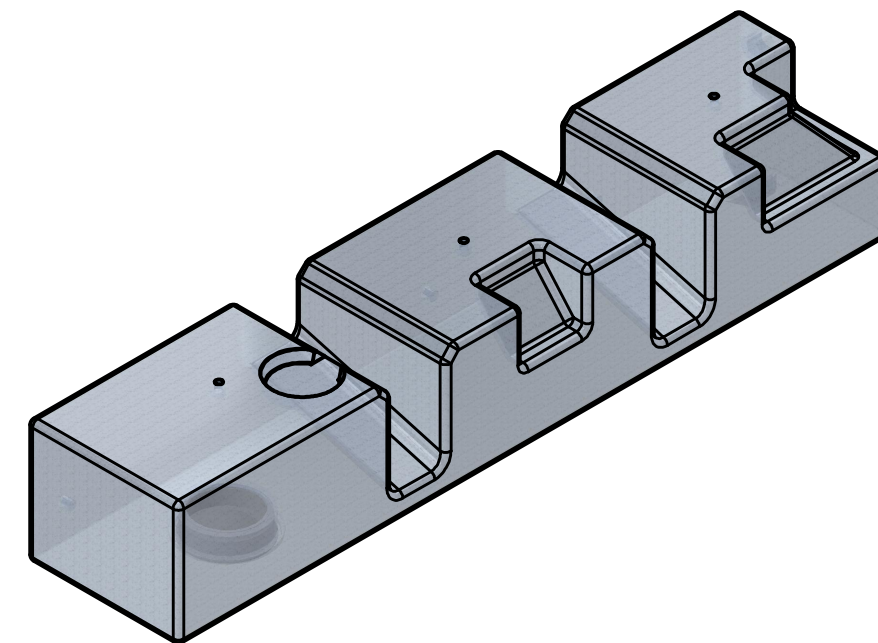
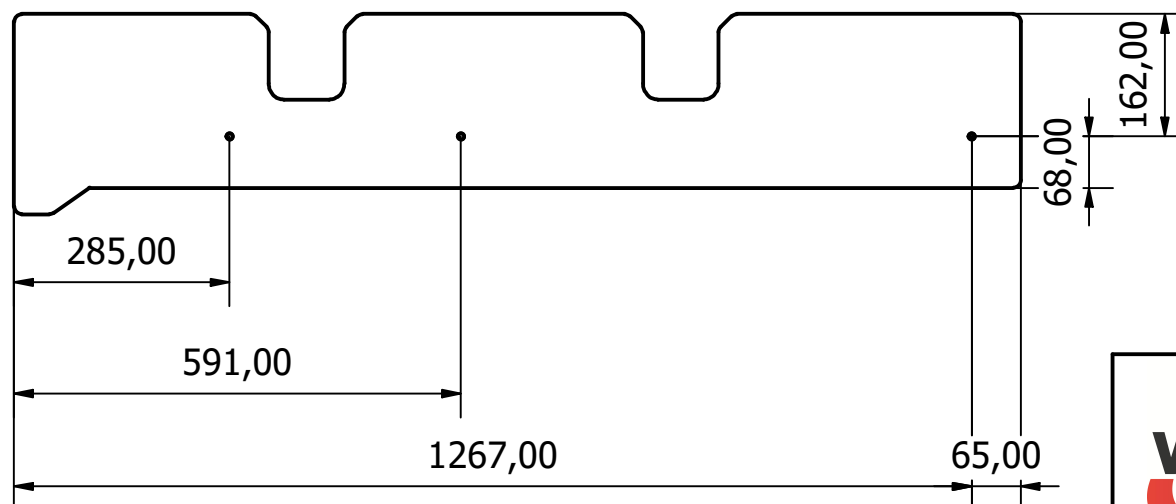
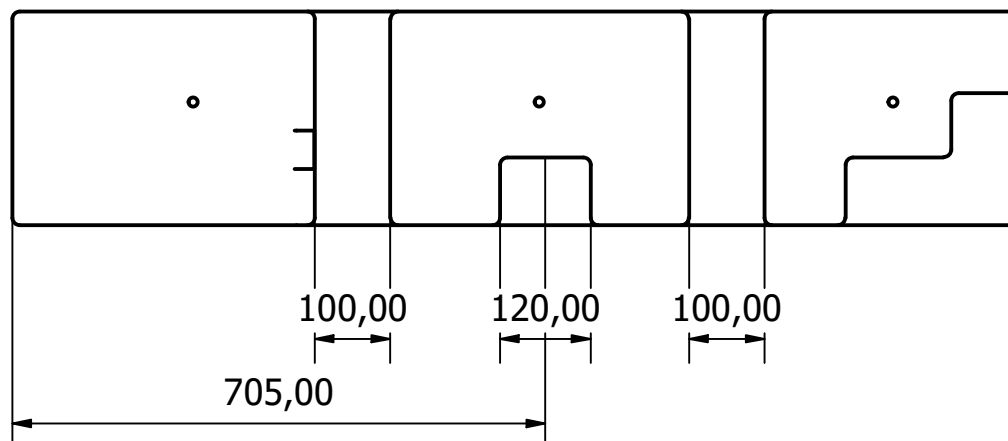
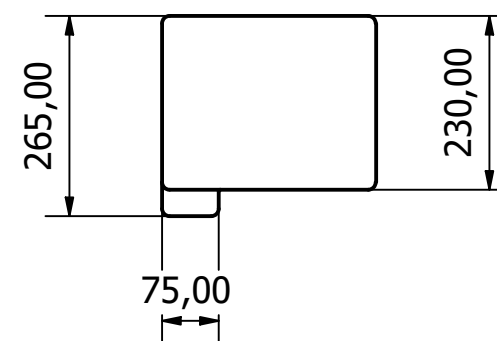
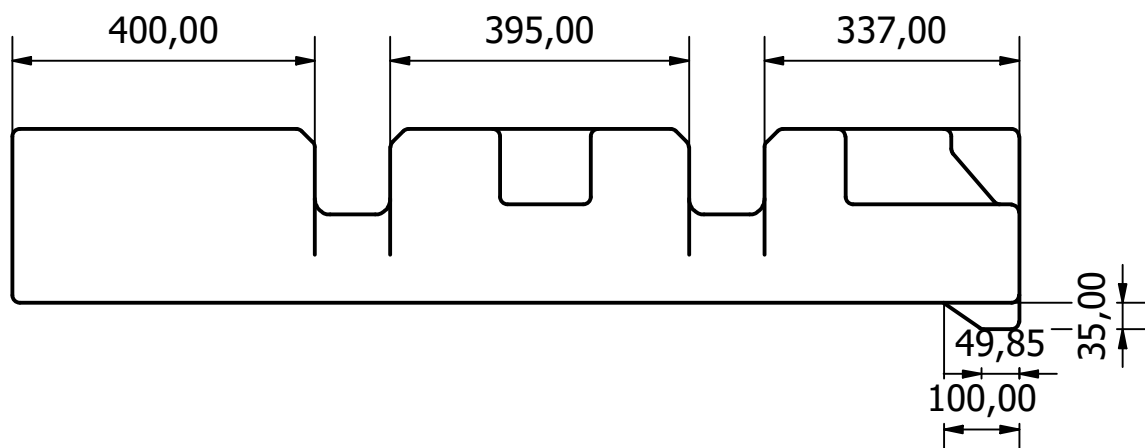
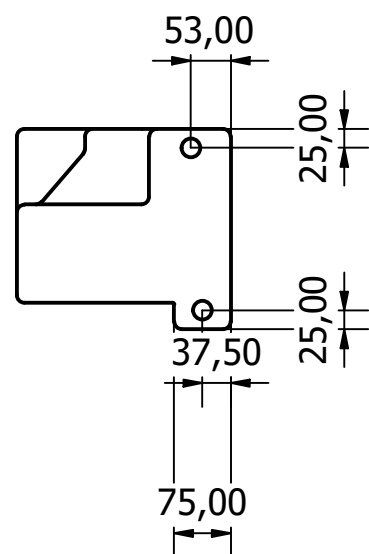
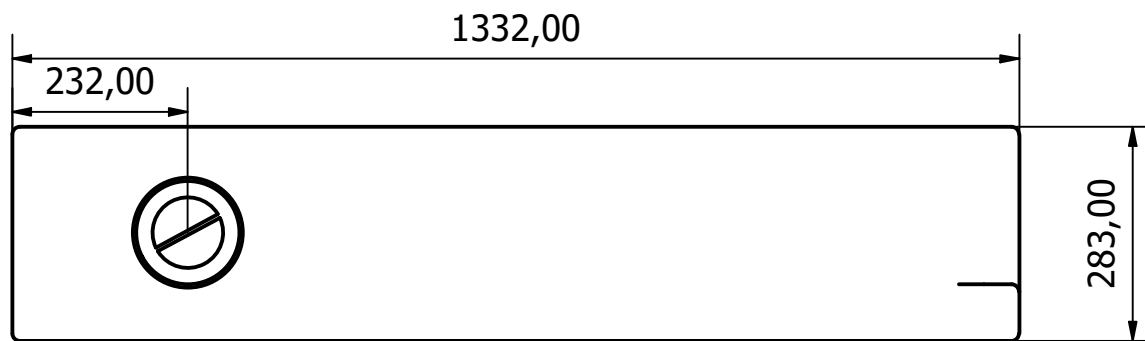

REV	ZONE	DESCRIPTION	DATE

wydale
 Wydale Plastics Ltd
 Cathole Bridge Rd,
 Crewkerne,
 Somerset,
 TA18 8RF
 Tel: 01460 73212
 Fax: 01460 77348

THIS DRAWING AND THE INFORMATION THEREON IS THE SOLE PROPERTY OF WYDALE PLASTICS LTD AND SHALL NOT BE COPIED OR REPRODUCED WITHOUT THE CONSENT OF WYDALE PLASTICS LTD. DIMENSIONS ARE ALL IN MM UNLESS OTHERWISE STATED.
 ALL TOLERANCES +/- 1MM UNLESS STATED.

CUSTOMER: Wydale Plastics Ltd	
PROJECT: Crafter 63 Litre MWB Cill Tank	
DRAWN DATE: 11/10/2022	DESIGNED BY: Rory
CHECKED BY:	
SHEET 1 OF 1	REV A
DRAWING NO:	

