

DIMENSIONS OF TRIPLE PUMP UNITS							
MODEL REF	DN1	DN2	B	H	H1	L	M
3MX3-2RS/24DPT	2.1/2"	2"	900	920	130	676	540
3MX3-5RS/24DPT	2.1/2"	2"	900	920	130	725	540
3MX3-6RS/24DPT	2.1/2"	2"	900	920	130	760	540
3MX3-7RS/24DPT	2.1/2"	2"	900	920	130	834	540
3MX3-8RS/24DPT	2.1/2"	2"	900	920	130	858	540

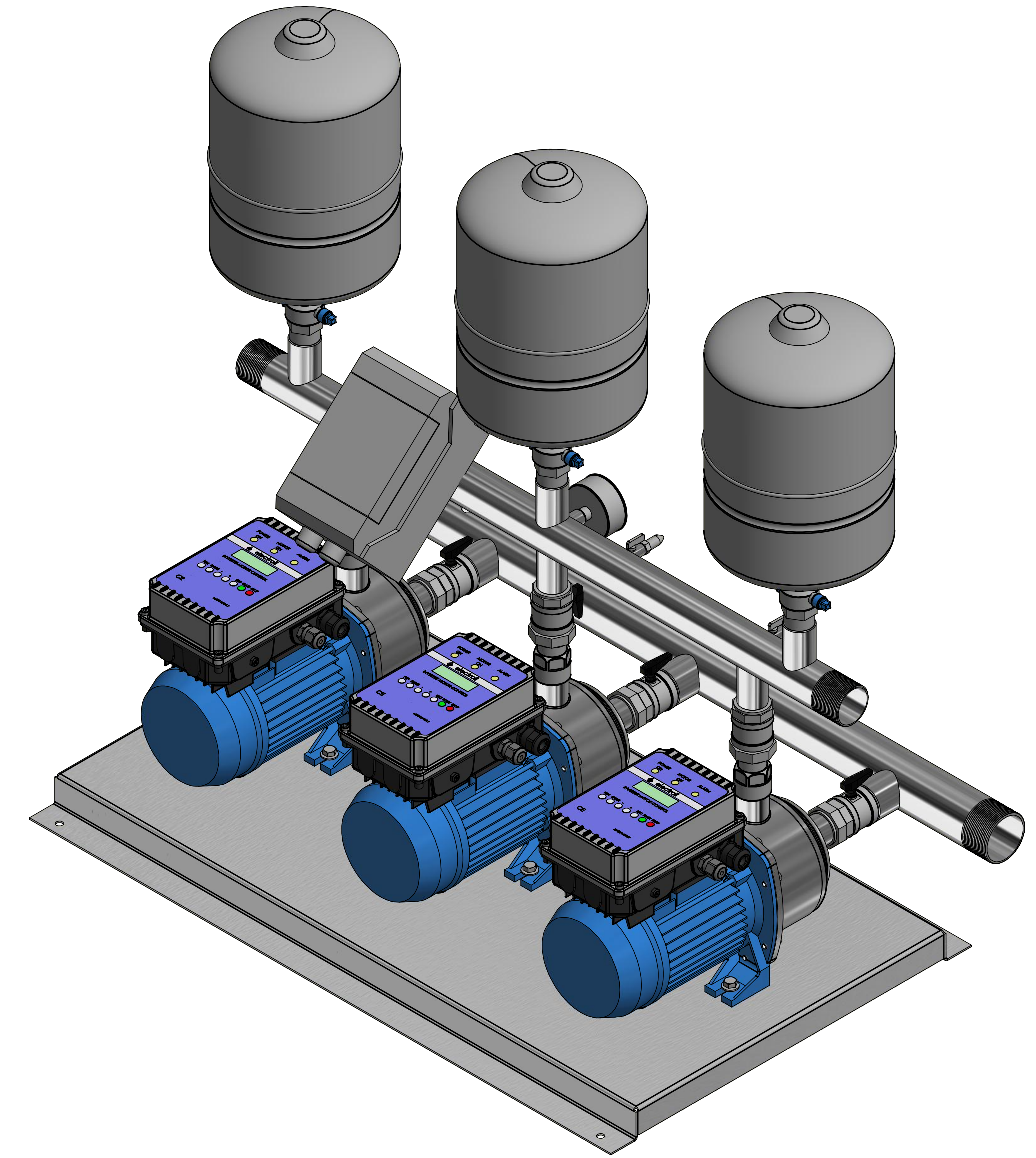
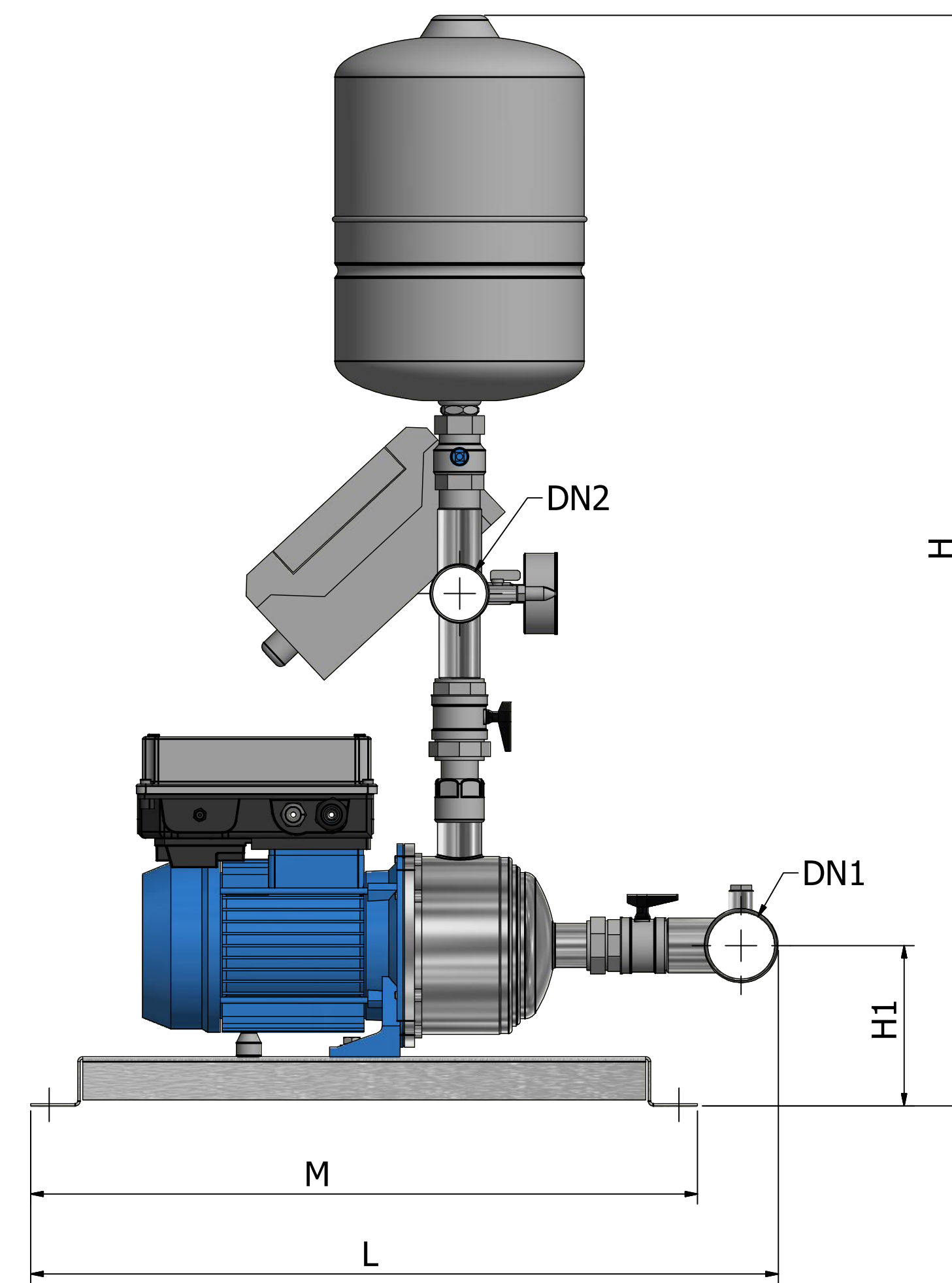
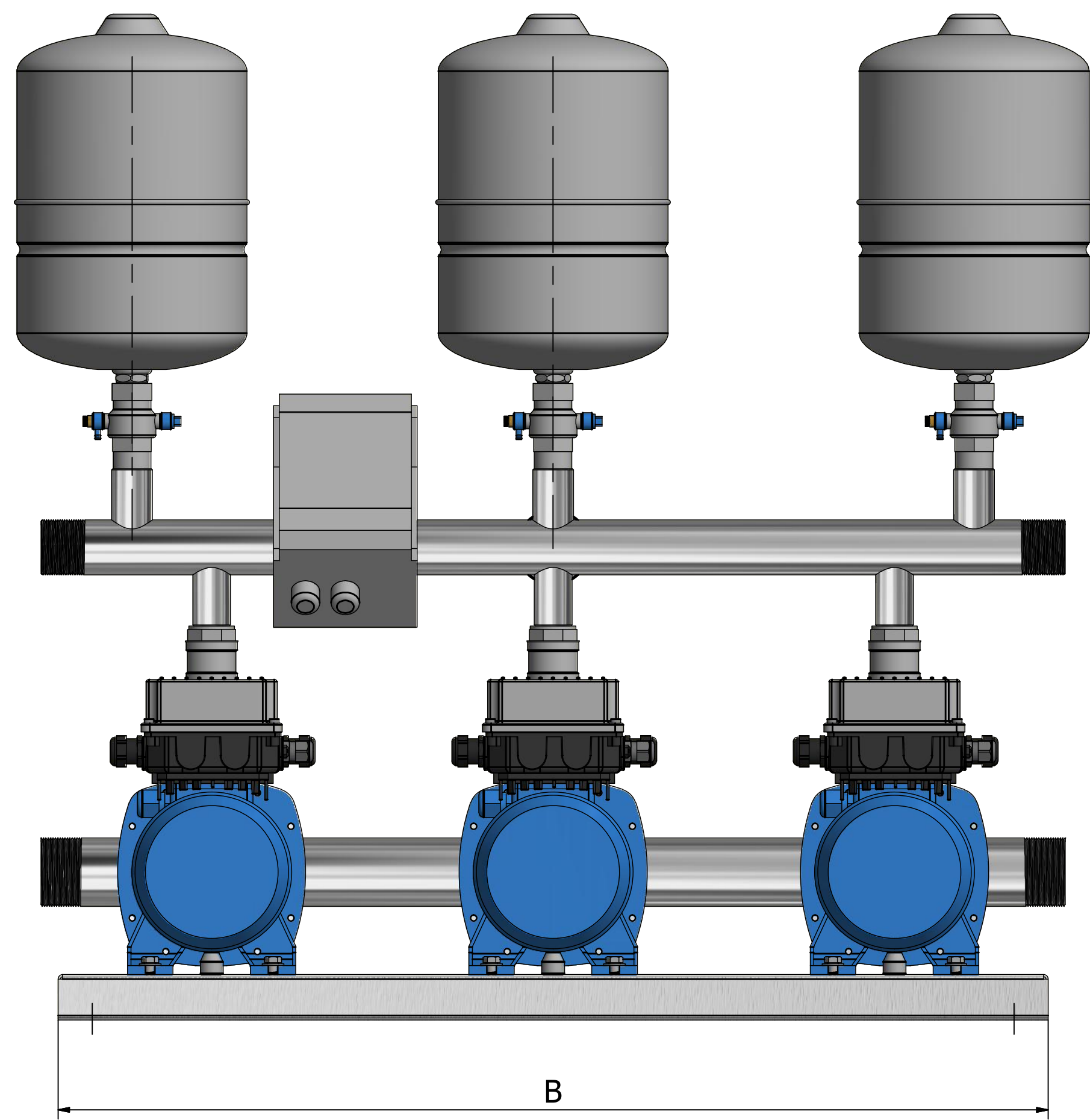

Rev	Date	Description						
THIRD ANGLE PROJECTION								
THIS DRAWING IS CONFIDENTIAL AND MAY NOT BE USED, COPIED OR DISCLOSED TO ANYONE WITHOUT THE PERMISSION OF D.P. & T.								
PRODUCT CODE		PRODUCT DESCRIPTION TRIPLE SERIES						
Drawn By:	R.U.	Checked By:	C.W.	Approved By:	C.W.	REV	1	SHEET 1 OF 1
Drawn Date:	01/02/2021	Checked Date:	01/02/2021	Approved Date:	01/02/2021	SIZE	A3	SCALE 1:4