

General Operating Instructions for Pressure Washers

Model	
Serial No.	
Engine No.	
Year of Manufacture	

Pressure Washer

Operating Instructions

This manual and any other literature supplied should be read thoroughly before attempting to operate the Power Washer. Pay particular attention to any instructions relating to safety, and the starting, stopping and maintenance of petrol and diesel engines.

THESE INSTRUCTIONS SHOULD BE KEPT WITH THE MACHINE AT ALL TIMES.

This manual has been compiled to give all the basic information to operate a Pressure Washer safely and effectively. It is recommended the manual and its accompanying final manufacturers literature be read and understood before attempting to assemble or operate the equipment. Following these simple instructions will ensure operator safety and prolong the life of the power washer.

Our policy is to improve our products continuously and we therefore reserve the right to discontinue or change specifications, models or designs without notice or obligation.

Appendix 1. Lance variations

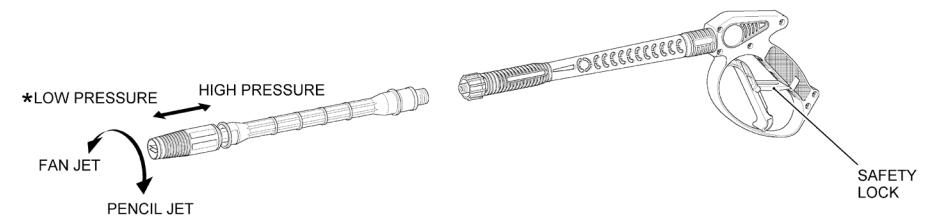

MULTIREG NOZZLE WITH SPLIT LANCE ASSEMBLY

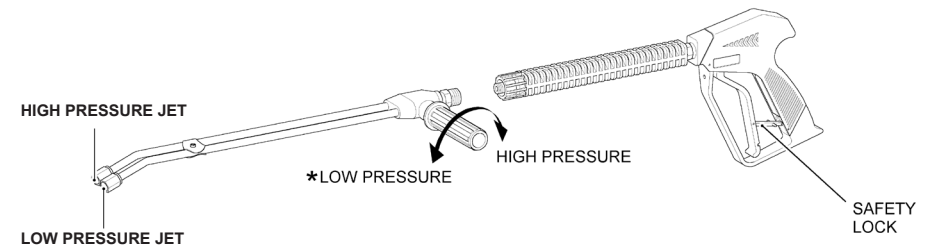

SPLITTABLE TWIN LANCE ASSEMBLY

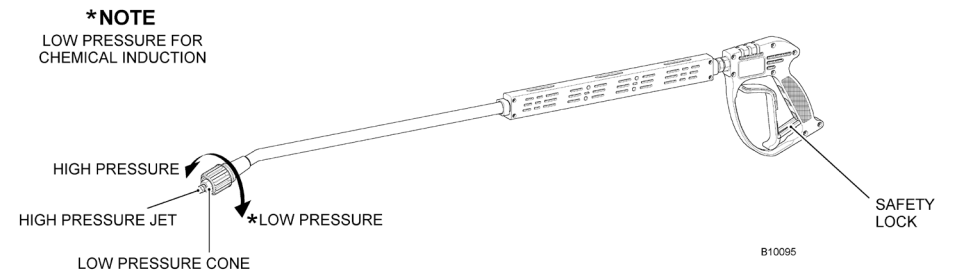

FIXED SINGLE LANCE WITH ADJUSTABLE NOZZLE

9.

Fault Finding

Symptom	Possible Cause	Remedy
Pump running normally but pressure low. Nozzle badly worn	Lance in low pressure mode Pressure Regulator valve Pump sucking air. Worn piston packing	Check and adjust Check and adjust Check water supply and possible air ingress. Check and/or replace Seek professional advice
Fluctuating pressure	Blocked water filter Pump sucking air	Check filter, clean or replace if necessary. Check integrity of suction hose and connections.
Pressure low after a long period of normal use.	Nozzle badly worn	Check and/or replace
Pump noisy.	Pump sucking air Excessive temperature of liquid in pump Worn bearing or valves	Check integrity of suction hose and connections. Reduce temperature to below 60°C, do not allow pump to idle for long periods. Seek professional advice
Presence of water in oil.	Ingress through breathers Worn oil seals	Replace oil, do not wash engine or pump Seek professional advice
Water dripping from under pump.	Worn piston packing	Seek professional advice
Oil dripping from pump/gearbox/engine.	Worn oil seal	Seek professional advice
Excessive vibration in lance/delivery line.	Water supply low Ingress of air into suction line Irregular functioning of valves	Check adequacy of water supply. Ensure suction filter is below water level. Check integrity of suction hose and connections. Seek professional advice

10. Warranty

See final manufacturers terms and conditions

1. Index

Equipment Variants and Optionssection 2
 Safetysection 3
 Description of Main Features.....section 4
 Installationsection 5
 Operation.....section 6
 Maintenancesection 7
 Storagesection 8
 Fault Finding.....section 9
 Warrantysection 10
 Lance Variations appendix 1
 Special Models appendix 2

2. Equipment Variants and Options

This equipment has been designed and manufactured for the high pressure washing of machinery, buildings etc, using water and detergent. Use only a recommended detergent.

It should not be used for washing electrical equipment, people, animals and surfaces that are loose and easily damaged.

This manual deals with the following variants of pressure washers,

Power input Electric motor, petrol and diesel engines.

High-pressure Multi cylinder plunger pumps
Pump

Transport frame Rigid steel frames in either static or wheeled options.

3. Safety

Power washers should only be used by fully trained, competent persons. They should not be used by untrained or inexperienced users.

Care should be taken when handling the pressure washers as they have uneven centres of gravity and may topple over when lifted.

3.1 Suitable Persons

Operators should be physically fit and free from the influences of drugs or alcohol.

Prolonged periods of operation are strenuous and operators should be encouraged to take regular breaks. If you have any doubts about your fitness to operate this equipment, seek professional advice before proceeding.

3.2 Protective Clothing

Operators and assistants should wear the following Personal Protective clothing and equipment: -

Waterproof boots with good non-slip soles

Waterproof overalls

Waterproof gloves

*Goggles or full-face protection to at least BS EN166

**Ear Muffs or Ear Plugs to give protection to at least EN352-1. EN352-2

3.3 Use in confined spaces

Diesel and Petrol engines produce fumes and toxic gases, use only in well-ventilated spaces.

To prevent the build up of flammable vapours the charging of petrol and diesel tanks should not be done in confined spaces. Any spillages should be cleaned up and any absorbent material used should be disposed of in a proper manner.

3.4 General Safety

Check all hoses and couplings for tightness and damage, loose connections should be tightened and damaged hoses replaced.

Ensure the workspace is clear and free from obstructions; consideration should be given to the erection of fences or sheeting to prevent injury to others.

High-pressure lances react 'Kick Back' when the operating trigger is pulled.

Ensure you have a good firm footing and anticipate this reaction.

Extra care should be taken when working at heights, scaffolding should be in good condition, secure and properly fenced, working from ladders is not recommended.

The high-pressure stream can be dangerous, do not point the stream directly at others or submit them to the fine over-spray.

3.5 Control of Vibration at Work Regulations 2005

Any modifications or accessories added or use with this machine may affect the vibration levels. Under the Control of Vibration at Work Regulations it is the employers duty to manage the exposure to vibration and implement training and health surveillance for employees.

Under the Supply of Machinery (Safety) Regulations 1992 (SMSR), you should ensure equipment is in good condition and maintained in accordance with the manufacturers instructions, any modifications or accessories added to this machine should be assessed for safe operation and vibration, then implement appropriate measures.

7. Maintenance

Activity	Each/ First Use	3 months or 50 Hours	12 months or 100 hours
Inspect / top up oil levels Engine Gearbox Pump Electric Motor	* * * NA	NA	NA
Change Oil Gearbox (EP90 Gear Oil) Pump (SAE30 Pump Oil) (Change engine oil in-line with the engine manufacturers recommendation), or at -		* * First 3 months or 50hrs only)	* * *
Clean water inlet filter	*		
Inspect and or change, engine/gearbox drive key Inspect Change (It is recommended that you consult your dealer before performing this item of maintenance)			* * (if required)
Inspect high-pressure hose and its connection for tightness and damage	*		
Inspect suction hose and its connections for tightness and damage	*		
High pressure jet Inspect Change	*		*
Pneumatic tyres Check/Inflate tyre pressures (0.7bar, 10psi)	* *		

8. Storage

Disconnect pressure hose and lance, draining water from the hose.

Disconnect water feed hose, draining water from the hose.

Wash out detergent hose with clean water, draining water from the hose.

Turn over the engine by hand to expel water from pump.

Ensure the equipment is clean and dry before storage.

The equipment should be stored in a **dry and frost** proof place.

6. Operation

6.1 **Start Engine/Motor** (Note: Depress the lance trigger to release water pressure before starting).

Refer to accompanying booklet relating to the type of engine/motor fitted.

6.2 **Using High Pressure Lance** (Note: See Appendix 1 for lance type and operation)

Release the lance safety catch, which is located behind the trigger.

6.2.2 Point the lance downwards and towards the object being cleaned.

6.2.3 Squeeze the trigger to start the high-pressure jet, proceed to wash the object. Adjust the working pressure by turning the pressure regulator knob + or - to suit the application (fig 2, item 13). Never direct the high-pressure stream at the engine or pump as this could cause irreparable damage.

WARNING: - High-pressure lances react 'Kick Back' when the operating trigger is pulled. Ensure you have a good firm footing and anticipate this reaction.

6.2.4 Release the trigger to stop the high-pressure jet.

6.3 **Washing using detergent**

Attach the detergent induction pipe to the power washer, (fig 2, item 1) placing the opposite filter end into the detergent container. Select the low pressure setting on the lance, (see appendix 1 for details of your lance) and spray the water/detergent mixture onto the object being cleaned. Leave the detergent for the period recommended by the chemical manufacturer allowing it time to work, washing off with clean water. The volume of detergent used can be controlled by means of the regulator on the suction valve (see fig 2. item 3).

6.4 **Switching Off**

Release trigger.

Stop drive engine/motor, (refer to additional literature / handbook supplied, relating to the type of engine/motor fitted, remembering to switch off ignition after use to prevent draining the battery, electric start engine models only).

Depress the high-pressure lance's trigger to release the pressure in the high-pressure hose.

Disconnect water supply.

WARNING: Do not let the pump idle in By-Pass for lengthy periods, if you intend to break from work for more than 5 minutes, switch the machine off. Should the machine run for longer period, the temperature of the re-circulating water will increase rapidly and could risk damaging the pump seals. (Models with internal by-pass only). Running power washers should never be left unattended.

*** Note: Goggles or Full Face Protection.**

The wearing of eye and face protection in hazardous areas is a requirement under regulation 4 of the personal protective equipment at work regulations 1992.

Regulation 4 requires employers to provide suitable personal protective equipment to employees who may be exposed to risks affecting their health and safety.

Full Face Protection.

High speed flying particles or chemical splashes are rarely aimed directly at the eyes. A full face visor offers the maximum protection in extreme conditions. Full face shields offer a wide area of protection and because of the all round ventilation, remain mist free even in wide temperature swings.

Chemical Splash.

Chemical splashes and vapours can hit you from all sides. It's important that full eye enclosure is selected, e.g. Unvented goggles. Full face shields will also protect the whole face from liquid splashes. Those with chin guards should be selected where there is a danger of splash deflecting up from work surfaces.

Impact.

Impact hazards are caused by fast moving particles from the cleaning operation. The potential impact speed must be assessed before selecting the most appropriate protection. Safety glasses could be dislodged by high velocity impacts, in which case goggles or face shield should be selected.

**** Note: Ear Muffs or Ear Plugs.**

The noise at work regulations require that from February 2006 persons working in noise levels between 80dBA and 85dBA must be provided with suitable hearing protection on request. If noise levels are above 85dBA then hearing protection must be supplied and worn.

4. Description of Main Features (fig 2)

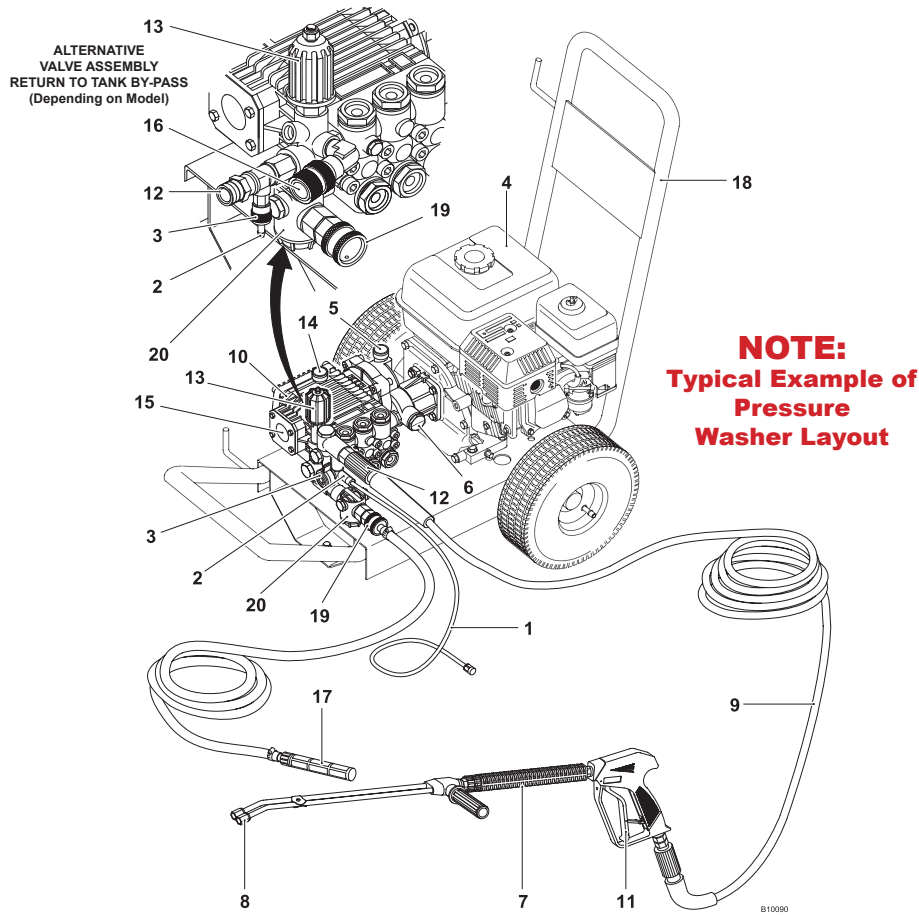

Fig 2 Description of main features

- | | |
|---|---|
| 1. Detergent Hose | 11. Operating Trigger and Safety Catch |
| 2. Detergent Hose Connection | 12. Pressure Hose Connection |
| 3. Detergent Rate Control | 13. Pressure Regulator |
| 4. Drive Engine / Electric Motor | 14. Pump Dipstick |
| 5. Gearbox Dipstick (Depending on Model) | 15. Pump Sight Glass |
| 6. Gearbox Sight Glass (Depending on Model) | 16. Return (external return to water supply depending on model) |
| 7. Hand Lance | 17. Suction Filter |
| 8. High/Low Pressure Nozzle | 18. Typical Transport Frame |
| 9. High Pressure Hose | 19. Water Inlet |
| 10. High Pressure Pump | 20. Water Inlet Filter |

5. Installation

- 5.1 From the pump and gearbox (if fitted) remove the 'Red' travel plugs, replacing them with the yellow-topped dipsticks. Check all oil levels, top up if necessary.
- 5.2 Fill engine with oil and fuel, see engine manufacturers handbook for details of oil and fuel types.
- 5.3 Connect the battery leads. (Electric start engine models only).
- 5.4 Electric motor driven pump units and their associated controls should only be installed by a fully qualified electrician.
- 5.5 Connect the suction hose to the Power Washer (**fig 3**). Ensure the connection has no air leaks. Air leaks on the suction hose connection will impair the performance of the machine.
- 5.6 Connect the water return line to its connector and place the other end in the water supply container. Bypass to tank models only (**fig 2 item 16**) (**Fig 4 No.1**)
- 5.7 Submerge the opposite end of the suction hose and its suction filter in a suitable container containing the water supply (**fig 4 No.2**). Ensure the filter is always kept below the water level. Fixed installations are best supplied from a header tank with appropriate height above the pump to suite the application. Ensure an in-line filter is installed in the inlet feed to the pump and make sure any return by-pass water to the tank is baffled to prevent turbulence within the tank. (Refer to the pump installation instruction book for full details).
- 5.8 Connect the high-pressure hose to the power washer (**fig 5**) and to the lance (**fig 6**). Tighten as appropriate, do not over tighten. Ensure that the trigger safety catch is in the **ON** position whilst making these connections.

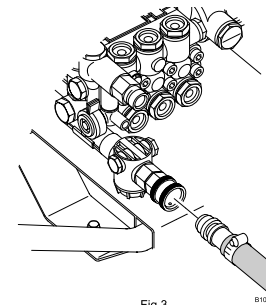

Fig 3

Fig 3. Connect the suction hose.

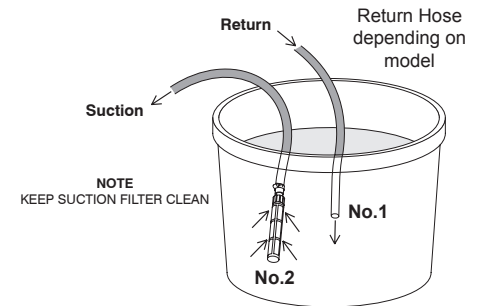

Fig 4. Submerge the suction hose.

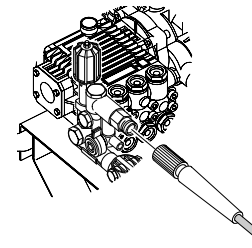

Fig 5

Fig 5. Connect the High-Pressure Hose to the Power Washer.

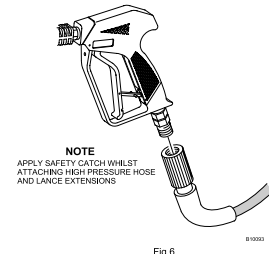

Fig 6

Fig 6. Connect the High-Pressure Hose to the Lance.