

Klargester

PSTOR E Horizontal Range

Installation &
Operation Guidelines



Part Code	1013563
Issue	01
Description	ECN 2020
Date	January 2024

Health And Safety

Please read and follow for your own and others safety.

You must read these warnings carefully before installing or using the equipment. Please ensure that you have performed a risk assessment before commencing any installation. Note that the risk assessment should be performed by a person who understands the hazards of the work, and the work environment. Note that it must be *suitable and sufficient*, i.e., adequately considers risks and ensures controls in place to mitigate risks.



You must observe all-hazard labels and take appropriate action to avoid exposure to the risks indicated. Always ensure that all relevant documents are supplied with the equipment when being transferred to a new owner.

1.1 General guidelines

- Only experienced and competent person(s) should carry out the installation.
- The unit must have a *Pre-Service Agreement Inspection* by an approved engineer.
- Take care to maintain correct posture, particularly when lifting.
- Use appropriate lifting equipment when necessary.
- A qualified electrician should carry out electrical work deemed necessary.
- The covers must be kept locked.



1.2 Personal Protective Equipment (PPE)

- We recommend the use of a dust mask and gloves when cutting GRP components.
- Person(s) carrying out maintenance on the equipment should wear suitable PPE.



1.3 Maintenance and Inspection Procedures

If you wish to inspect the equipment's operation, please observe all necessary precautions as stated in your risk assessment; including those listed below.

- The power supply must be isolated at the control panel(s) before lifting the covers.
- If the equipment should run with the covers off, care must be taken to avoid contact with moving parts and electrical components or conductors.
- Once the power has been isolated, the control panel must be kept locked shut to avoid accidental reconnection while work or inspection is being carried out.

1.4 Working Area

- Ensure that the working area is adequately lit.
- Ensure that you are familiar with the safe working areas and its access and egress.
- Use only the designated access walkways.
- Do not walk on the cover or deep well safety mesh(es).
- Always keep proper footing and your balance, avoid any sharp edges, or restricted points.

1.5 Desludging

- Desludging should be carried out by a licensed waste disposal contractor holding the relevant permits to transport and dispose of sewage sludge in your region/area.

Introduction

Thank you for choosing a Kingspan product. This manual will help you to keep it operating efficiently over a long service life. Please read this manual thoroughly, preferably before installation.

This manual should be referred to by:

- The installer
- The electrician
- The service engineer.
- The maintenance engineer.
- The desludge contractor
- The owner/user

These Guidelines represent Best Practice for the installation of the above packaged pump stations (wastewater application). It must be noted, however, that these Guidelines are of a general nature. It is the responsibility of others to verify that they are appropriate for the specific ground conditions and in-service loads of each installation. Similarly, any information or advice given by employees or agents of the company regarding the design of an installation must be verified by a qualified specialist (e.g., Civil engineering consultant).

Handling & Storage

Care must be taken to ensure that units are not damaged during delivery and handling on site. Please take care and place unit so that it cannot fall and become damaged.

The design requirements of the product will frequently mean that the centre of gravity of the unit is “offset”. Care must therefore be taken to ensure that the unit is stable when lifting and that loads are evenly distributed during lifting.

Lifting equipment should be selected by taking into account the unit weight, length and the distance of lift required on site.

We accept no responsibility for the selection of lifting equipment.

CONTENTS

Health And Safety	2
Introduction	3
Handling & Storage	3
1. Tank Overview	5
2. PSTOR E Horizontal Range Site Delivery Checklist	6
3. General Installation	7
4. Chamber Installation	8
5. Operational Description	13
6. General Maintenance	14
7. How to Keep your Pump Station Running Sweetly	14
8. Warranty	15

1. Tank Overview

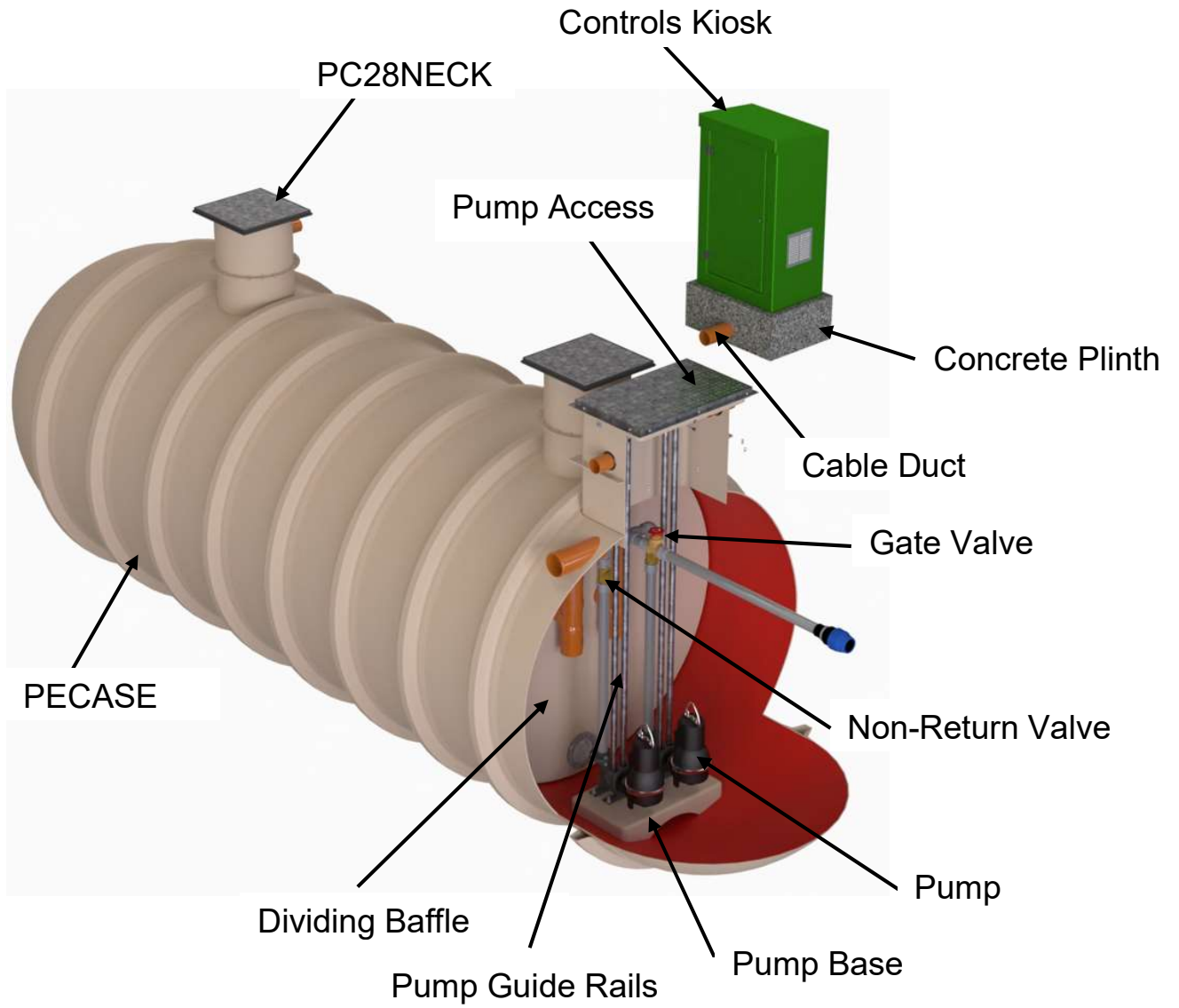

2. PSTOR E Horizontal Range Site Delivery Checklist

The delivery paperwork will have 3 no. items listed; check that the Tank Code (Item 1), Neck Assembly Code (Item 2) and Pump code (Item 3) are the same as the codes on the units delivered. Each module delivered will be clearly identified as per list below.

Example:

Top Level Product Code - (code)

Item 1 - (code) - (Tank Code)

Item 2 - (code) - (Neck Assembly Code)

Item 3 - (code) – (Pump Code)

GRP Chamber (PC18CASE / PC28CASE)

1. Tank length & neck quantity vary, check PSTOR ordered (See Table 1)
2. Multiple tanks can be supplied depending on storage volume requested.
3. Check tank immediately for any damage.
4. Please check your order and cross reference with relevant sales drawing.

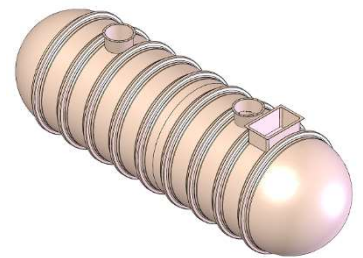

Extension Necks & fittings (PC28NECK)

5. Extension neck heights vary, check invert / height requested.
6. Extension neck quantities vary, check PSTOR ordered.
7. Check extension necks immediately for any damage.

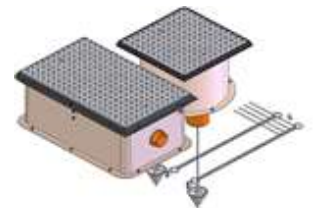

Pumps, Pump Lifting Gear, Control Panel & Floats (PC28PUMP)

8. Qty 2 pumps required for all PSTOR units, check quantity.
9. Qty 4 floats required for all PSTOR units, check quantity.
10. Qty 4 shackles and 2 chains required for all PSTOR units, check quantity.
11. Qty 1 control panel required for all PSTOR units, check quantity.
12. Guide claw with fixings
13. Pump seals or gaskets (if applicable)
14. Guide rails, diameter and length vary, for deep invert PSTOR.
15. Neck and Pipe fixings, quantities vary. Check PSTOR ordered.
16. Check all items immediately for any damage.



Additional Items Required (Not Supplied as Standard).

- Electrical Cable for connections between control panel and pumps/floats (Check IEE regulations latest edition for correct specification).
- External Pipe work, PVCu Inlet/Duct connections and ABS/Ductile Iron Outlet pipe work (material dependant on PSTOR ordered).
- Special loading access covers (for sites where non pedestrian specification access covers are required)

3. General Installation

- 3.1. Select a suitable location for the chamber. This will normally be at the lowest ground level on the site so that the facilities can be drained by gravity into the chamber, please consult architect.
- 4.2. Check that no other structure - or special access - is required over the selected position.
- 4.3. Provision can be made, if necessary, to place the chamber in a roadway, provided that the backfill, cover, slab and access cover are designed in accordance with the load requirements.
- 4.4. Check that no underground cable, pipe, or service duct lies beneath the selected position.
- 4.5. During installation care should be taken to ensure the tank is evenly supported so point loads through the unit are avoided.
- 4.6. Concrete Specification below is a *general* specification. It is not a site-specific installation design.

GENERAL CONCRETE SPECIFICATION IN ACCORDANCE WITH BS EN 206-1 (BS 8500-1)	
TYPE OF MIX	(DC) DESIGN
PERMITTED TYPE OF CEMENT	BS 12 (OPC): BS 12 (RHPC): BS 4027 (SRPC)
PERMITTED TYPE OF AGGREGATE (coarse & fine)	BS 882
NOMINAL MAXIMUM SIZE OF AGGREGATE	20 mm
GRADES:	C25 /30 C25 /30 C16 /20
	REINFORCED & ABOVE GROUND WITH HOLDING DOWN BOLTS REINFORCED (EG. FOR HIGH WATER TABLE) UNREINFORCED (NORMAL CONDITIONS)
MINIMUM CEMENT CONTENT:	C30 C20 270 - 280 Kg/M3 220 - 230 Kg/M3
SLUMP CLASS	S1 (25mm)
RATE OF SAMPLING	READY MIX CONCRETE SHOULD BE SUPPLIED COMPLETE WITH APPROPRIATE DELIVERY TICKET IN ACCORDANCE WITH BS EN 12350-1
NOTE: STANDARD MIXES SHOULD NOT BE USED WHERE SULPHATES OR OTHER AGGRESSIVE CHEMICALS EXIST IN GROUND WATER	

4. Chamber Installation

- 4.7. Excavate the minimum opening in the ground to receive the pump chamber, inlet, outlet & duct pipe work to be used (**Fig 1**). (NB: see table 1 on page 7 for tank lengths).

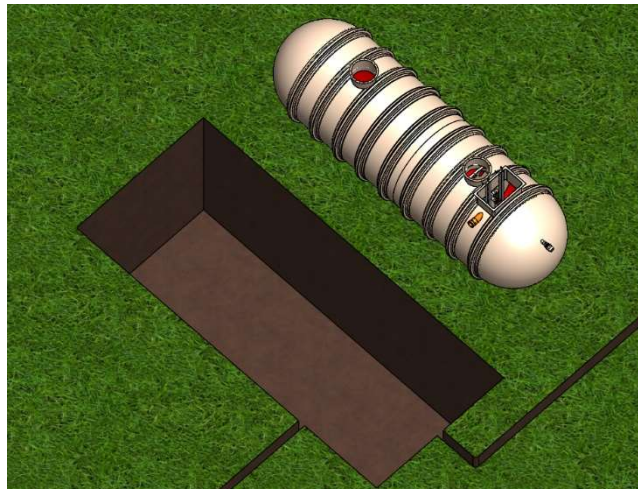

Figure 1

- 4.8. This opening must allow for a minimum of 250mm of concrete all around the chamber (**Fig 2**)

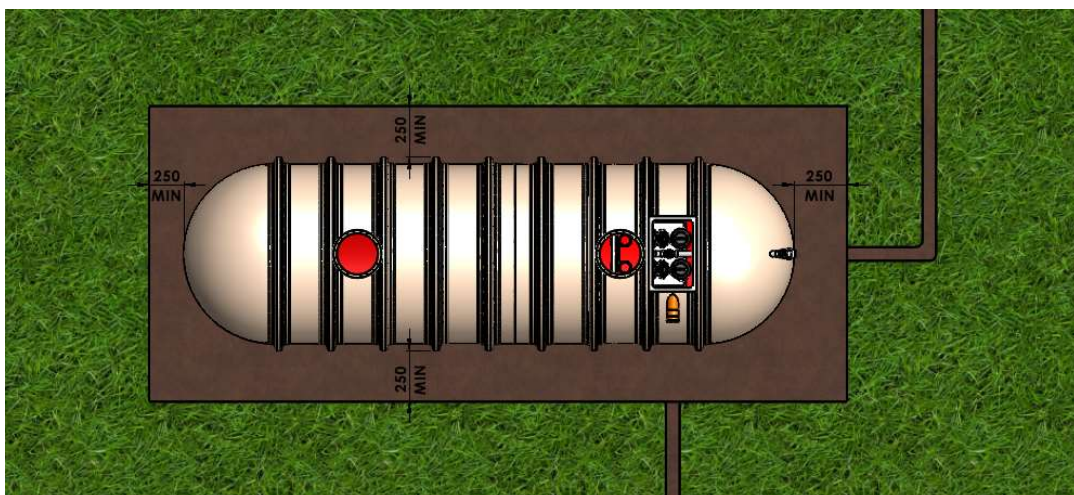

Figure 2

- 4.9. The depth of the excavation needs to be at least 150mm deeper than the overall tank depth, to allow for the concrete support slab to be constructed, (see PSTOR GA drawing for tank height).
- 4.10. If a machine is used to remove the soil, then the sides of the excavation should be shored for stability with trench sheeting and bracing systems to ensure a vertical wall from bottom to top of the excavation.
- 4.11. A sump should be excavated in case it is necessary to use a dewatering pump to remove any excess water during installation.

- 4.12. Construct a concrete base for the main pump chamber (ensuring a minimum concrete thickness of 150mm), ensuring the slab is flat and level and allow to set (**Fig 3**).
- 4.13. Lay a suitable concrete haunch for the chambers to sit on (**Fig 3**).

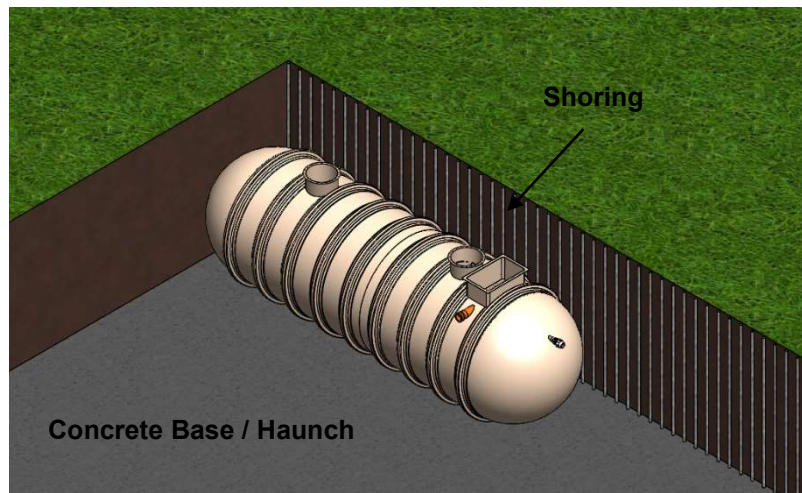

Figure 3

- 4.14. Ensure all sides of excavation are secured with appropriate shoring to avoid possibility of collapse.
- 4.15. Lower the pump chamber onto the haunch using suitable webbing slings and lifting equipment ensuring that the inlet and duct pipes are correctly aligned with the site pipe work (**Fig 3**).
- 4.16. Connect the site pipework (rising main) from the outlet on the pump chamber to the external pipework (**Fig 4**).
- 4.17. Pour no more than 300 mm depth of clean water into the unit, avoiding shock loads. Add water to each chamber simultaneously. DO NOT OVERFILL; the unit is not designed to hold water whilst unsupported.
- 4.18. Place concrete backfill to approximately 300mm deep under and to the sides of the tank, ensuring good compaction to remove voids. DO NOT use vibrating rammers. Continue adding concrete backfill, simultaneously keeping the internal water level no more than 200mm above the backfill level at all times, until the backfill is just below the underside of the outlet drain, giving sufficient room to connect the inlet and outlet pipe work (**Fig 4**).
- 4.19. Connect inlet pipe, rising main pipe work and cable ducting pipes when safe access to the backfill can be gained (**Fig 4**).

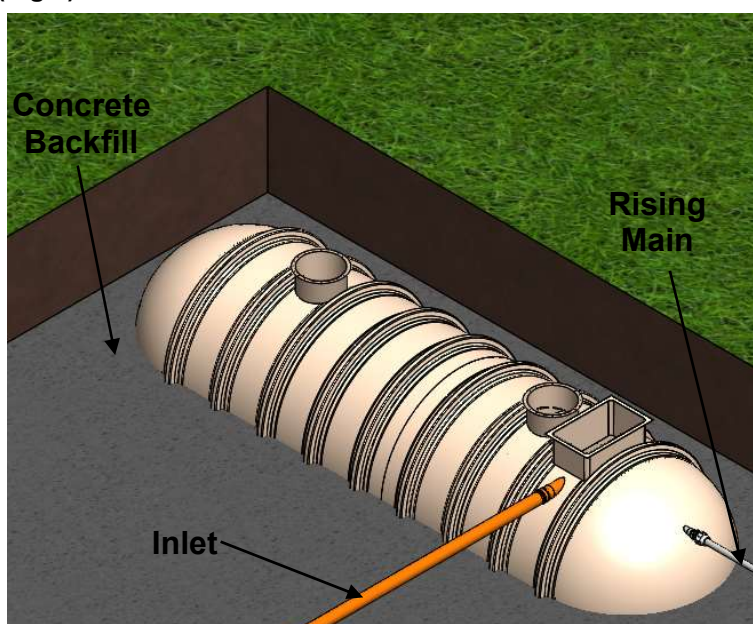

Figure 4

- 4.20. Wait for concrete to sufficiently cure and fit extension shafts to the main tank with mastic and M10x40mm bolts supplied, ensuring a watertight seal all round (**Fig 5**).

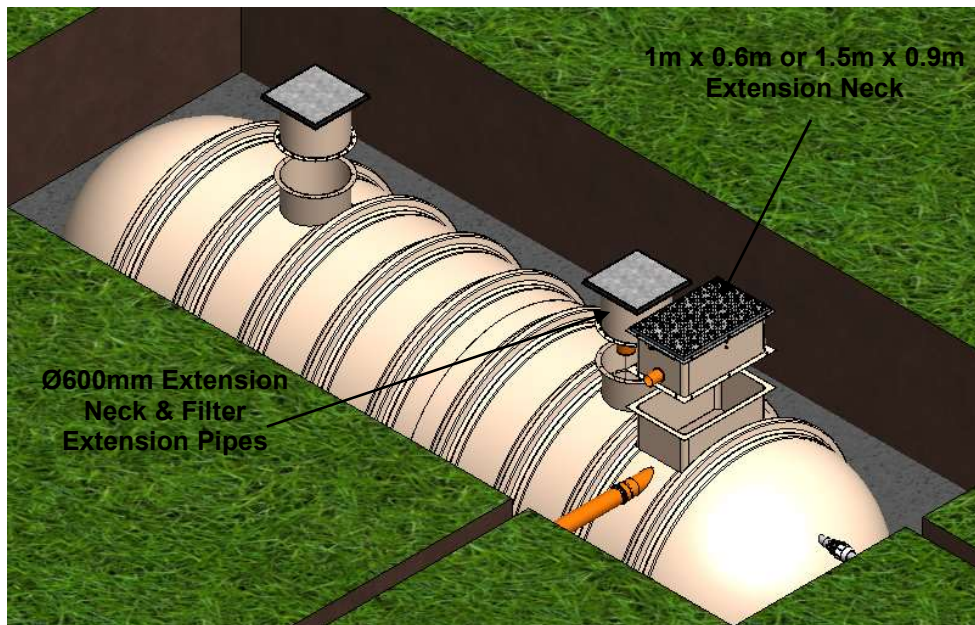

Figure 5

- 4.21. Continue backfilling around the tank, ensuring water level is no more than 200mm above the backfill level at all times, until you reach level required (**Fig 6**).

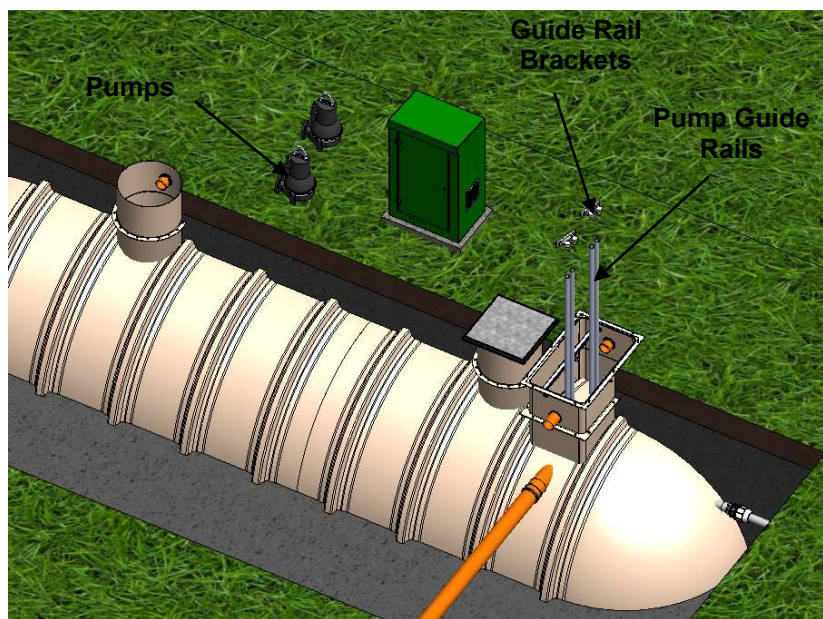
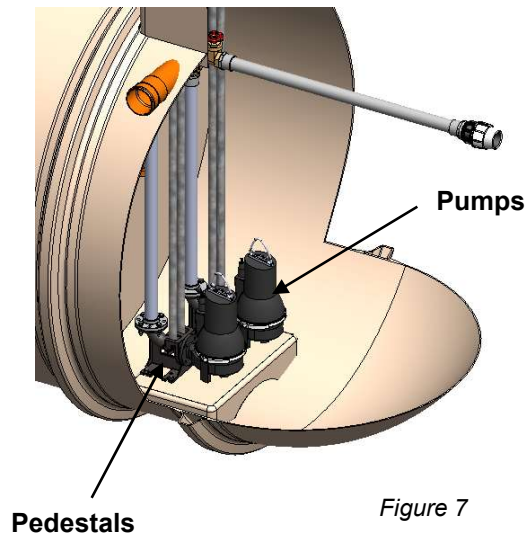

Figure 6

- 4.22. Finish off the surface of the excavation to the required level, depending on the final surface finish required (**Fig 6**).

Pump Fitting

- 4.23. Whilst fitting the pumps, ensure their electrical cable is securely fastened to the bracket on the neck so the cable can be easily fed to the electrical control panel/supply from ground level.
- 4.24. Run the electrical cable from the pumps, through the cable duct fitted into the neck of the 1.0m x 0.6m or 1.5 x 0.9m turret, to the control panel, a suitable waterproof connector will be required to extend the cable. **(Fig 7).**



Alarm Float Fitting

- 4.25. Thread the Float cables through the cable grommets in the mounting bracket located in the top of the 1.0m x 0.6m or 1.5m x 0.9m neck **(Fig 8)**. Set floats to the operational heights shown on drawing below **(Fig 9)**.

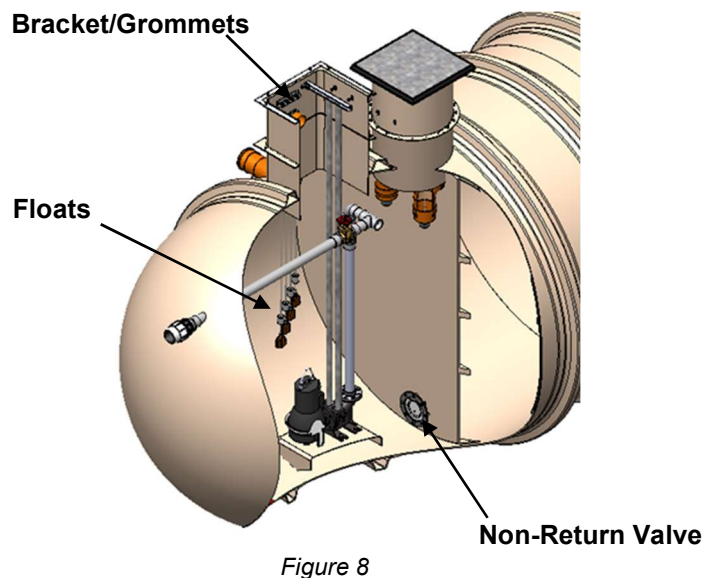

- 4.26. Thread the cables through the cable duct fitted to neck & pull through underground ducting to control panel/power supply. NB: all electrical connections and wiring should be carried out by a qualified electrician.

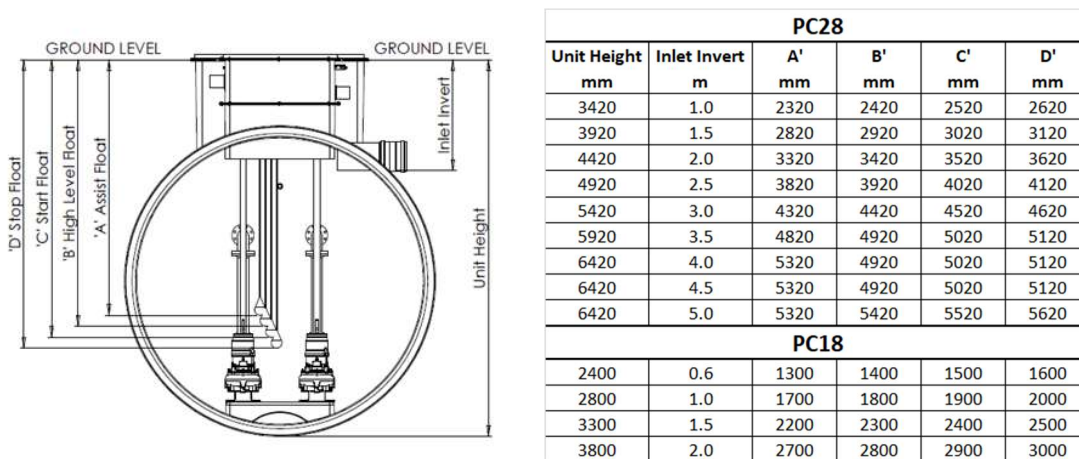

Figure 9

Mesh Cone Filter Fitting

- 4.27. Remove the 600mm² access cover (from manhole closest to pumps) and fit the mesh filter cones into the pipe work protruding up neck (Fig 10), lock handle in slots at top of pipe work, replace cover.

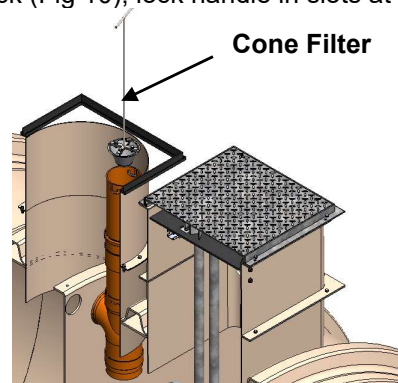

Figure 10

- 4.28. Ensure the system is correctly set up by a suitably qualified engineer or please contact our service department for help on this matter.
- 4.29. Once the unit has been correctly set up replace the pump security cover and all manhole covers to any open access shafts (Fig 11)

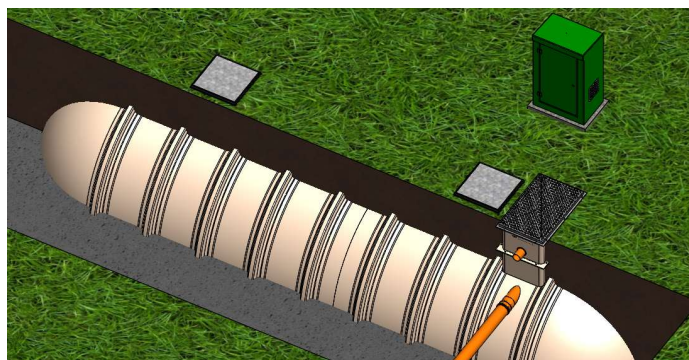

Figure 11

Deep Invert Units

The standard units include fitted pump guide rails, however, for units with deeper inverts i.e., 2000mm inlet inverts and above these need to be site fitted. Additional flanged extension necks are supplied with all 1.0m inlet invert and above products, Please be aware that this tank is non-structural at this depth, therefore the tank and extension necks must be surrounded by reinforced concrete structurally independent of the tank. The concrete surround must be designed by an appropriate civil engineer.

- 4.30. Use the mastic supplied and bolt through the flanges, from top to bottom using washers below the bolt head and above the nut. (Fixings supplied) Check that the flanges are fully sealed and watertight before completing the concrete backfill around each turret.
- 4.31. Temporarily strut extension necks during this procedure to avoid distortion or collapse as the necks are non-structural.
- 4.32. Pump stations with inlet inverts of 0.6m, 1.0m & 1.5m will have guide rails and top guide rail brackets pre-fitted. Guide rails and/or extension guide rails on units greater than 2.0m will be shipped separately with extension necks, to be fitted on site.
- 4.33. Continue back-filling in 300mm stages, ensuring minimum 225mm concrete thickness around the full length of the access shaft /extension necks. Failure to do this will result in necks buckling.
- 4.34. Leave until the concrete is fully cured. Each chamber should be filled with clean water up to the invert level of the outlet.

5. Operational Description

Pump Control Panels

- 5.1. Twin Pump Panels are designed to operate from 4 float switches i.e., stop / start / duty - standby & high-level alarm.
- 5.2. In "auto" the pumps will run under float switch control.
- 5.3. As the level rises the stop float contacts will close. When the start float switch contact closes, the duty pump will start. This pump will continue to run until the level falls below the stop float switch.
- 5.4. After each pump cycle the duty pump is alternate so that the other pump becomes the duty pump the next time the level reaches the duty pump start float.
- 5.5. If the level continues to rise to the high-level float, the high-level alarm light will illuminate. This alarm may be reset once the level is below the high-level float switch. Under high level conditions this lamp will be illuminated to indicate that there is either a pump failure or that the volume of influent is exceeding the discharge capability of the pump. The high-level alarm / beacon will need to be manually reset by the site operator once the cause of the high-level condition has been identified and resolved.
- 5.6. Should the duty pump have failed or is running, and the level continues to rise to the duty /standby pump start float, the second standby pump will start and continue to run until the level falls below the stop float switch.
- 5.7. Cable access is available from both the top & bottom end of the panel. Additional access can be gained from the sides but must be suitably glanded. The control panel has an IP54 rating. The cabling work and glanding to the panel needs to be of the same standard to maintain this rating.
- 5.8. Please ensure that the overload(s) within the panel are adjusted to match the Full load current of the pump(s) to ensure nuisance tripping is not encountered. Please contact our technical office for further advice if required.

PLEASE REFER TO WIRING DIAGRAMS SUPPLIED INSIDE THE CONTROL PANEL BEFORE INSTALLING THE ELECTRICAL EQUIPMENT

Important Notes

When positioning the chamber please check that sufficient cable has been ordered to allow the control panel to be placed in the required position.

It is most important that once the chamber is in position, with all the inlet connections made and before installing the pumps, that the drainage system is flushed through and all sand, debris etc. is removed from the chamber.

FAILURE TO DO THIS MAY INVALIDATE THE WARRANTY ON THE PUMPSETS

A cable duct is required, free from sharp bends, minimum diameter 75mm.

Additional Notes

If the chamber is going to be subjected to traffic & or vehicle loads, it is essential that a cover slab is constructed so there is no direct load onto the chamber. Also, a suitably rated access frame and cover must be obtained, and installed in such a manner that no loads bear directly onto the neck of the chamber.

When using a concrete backfill it is important to ensure that the mix is not too wet as this may exert floatation pressure on the pump chamber.

In all instances the pump chamber must be filled with clean water to keep pace with the backfilling process, this is to equalize the pressures exerted onto the unit and prevent the possibility of chamber deformation or flotation during installation.

IF IN DOUBT PLEASE CONTACT US FOR ADVICE.

IT SHOULD BE NOTED THAT THIS INFORMATION IS FOR GUIDANCE PURPOSES ONLY. IT IS THE RESPONSIBILITY OF THE CONTRACTOR TO ENSURE THAT THE INSTALLATION IS CARRIED OUT TO THE SATISFACTION OF YOUR REGULATING LOCAL WATER AUTHORITY, IN ACCORDANCE WITH THE PREVAILING GROUND CONDITIONS.

6. General Maintenance

The best way to achieve this is to arrange a contract with an approved Service provider. Please contact us on the phone number given for service contact details.

There will always be situations when a little self-help may be sufficient to avoid call out and we describe here some basic checks which may prove useful: Before opening the unit, please see Health and Safety Notes.

We recommend the unit is checked every 6 months to ensure there are no blockages or obstructions in the inlet and outlet pipes, also check that there is not excessive sludge build up in the bottom of the tank.

If in any doubt whatsoever, please contact your service provider.

7. How to Keep your Pump Station Running Sweetly

If a Pump Station serves your property, the likelihood is that the property is not connected directly to the mains sewer system.

Sewage pump systems are designed to handle foul water, natural human waste, and biodegradable products.

Other household waste and non-biodegradable products should never be disposed of through the drainage system.

Disposal of non-bio-degradable products will affect the reliability of all pumping stations, causing pumps to block and storage chambers to become congested with non-pumpable waste.

Bear in mind too that it isn't only the toilet that is connected to the station; anything that goes down the sink, bath.

THE FOLLOWING MUST NOT BE DISCHARGED INTO THE DRAINS

- Cleaning Rags
- Cloths
- Syringes & Hypodermic Needles
- Medicines & Medical Equipment. Take unused medicines to a pharmacist for safe disposal.
- Grease & Fat. These products tend to cool down, separate from the water and coagulate within the pump

chamber. Fat & grease encase the pump and floats, causing blockages and failure of pumps.

- Nappies, sanitary towels, incontinence materials, soft toys, tennis balls etc. It may seem a bit obvious to say this, but it is amazing what gets flushed down the loo from time to time, causing blockages of the drains and pumps.
- Even so-called disposable nappies and sanitary towels often do not degrade fully and can lead to malfunction, so it is best to dispose of them by other means. Fabric cleansing wipes & nappy liners can block pipework. They should not be flushed into the drainage system.

ROUTINE DE-SLUDGING AND SERVICING

Pump Stations over time accumulate settled solids. It is good practice to check and if necessary, empty/desludge these at the same time as any treatment unit.

It is vital to the systems ongoing operation and should be carried out regularly.

Mechanical and electrical servicing, particularly, must be performed by properly trained personnel, suitably qualified and experienced in this type of work.

8. Warranty

Taken from 'Kingspan's Terms & Conditions of Sale'

The company will replace or, at its option, properly repair without charge any goods which are found to be defective, and which cause failure in normal circumstances of use within a period of twelve months from the date of delivery.

This warranty is conditional upon:

- (a) the Buyer notifying the Company of any claim within seven days of the failure becoming discernible.
- (b) the Company being allowed a reasonable opportunity to inspect the goods so as to confirm that they are defective.
- (c) the goods not having been modified, mishandled, or misused and being used strictly in accordance with any relevant instructions issued by the Company.

The Company's liability under this Clause is limited to the repair or replacement of the defective goods, and does not cover costs of transport, installation, or associated site costs, if applicable.

The Company's liability to replace or repair the goods is in lieu of and excludes all other warranties and conditions, and in particular (but without limitation) the Company shall have no liability of any kind for consequential loss or damage.

For any further advice, please contact us.

A Warranty Form is included in this package, to register your unit for Warranty. Please complete ALL sections of the Form and return it at your earliest convenience.

Also within this package is a Notice, describing the necessary maintenance of the plant in use. This should be fixed within the building.

Contact Details

UK

Kingspan Water & Energy Ltd.

College Road North
Aston Clinton | Aylesbury
Buckinghamshire | HP22 5EW

T: +44 (0) 1296 633 000
F: +44 (0) 1296 633 001
E: klargestester@kingspan.com

www.kingspan.co.uk/klargestester

Ireland

Kingspan Water & Energy Ltd.

Unit1a | Derryboy Road
Carnbane Business Park
Newry | BT35 6QH

T: NI: +44 (0)28 3026 6799
F: ROI: 0818 544 500
E: klargestesterinfo@kingspan.com

www.kingspan.ie/klargestester

Kingspan Water & Energy Ltd.

Service Office Details:
180 Gilford Road
Portadown | BT63 5LF

T: NI: +44 (0)28 3836 4600
F: ROI: 0818 543 500
E: helpingyou@kingspan.com

www.kingspanservice.ie

We take every care to ensure the information in this document is accurate at the point of publication.
©Kingspan and the Lion Device are Registered Trademarks of the Kingspan Group in the UK, Ireland and other countries. All rights reserved. Registered in Country No.NI017631. Registered Office: 180 Gilford Road, Portadown, Co. Armagh, BT635LF. VAT GB412 5124 03

Mktg. Comp. Code (Covers only)

4491_11/23_v1

