

Clearwater BioAir

Installation & Operation Guidelines

DS1446B	BioAir 4 Gravity Sales Drawing
DS1447B	BioAir 4 IPS Sales Drawing
DS1448B	BioAir 6 Gravity Sales Drawing
DS1449B	BioAir 7 Gravity Sales Drawing
DS1450B	BioAir 8 Gravity Sales Drawing
DS1451B	BioAir Blower & Duct/Vent Drawing

Please request copy of specific sales drawing from our sales department

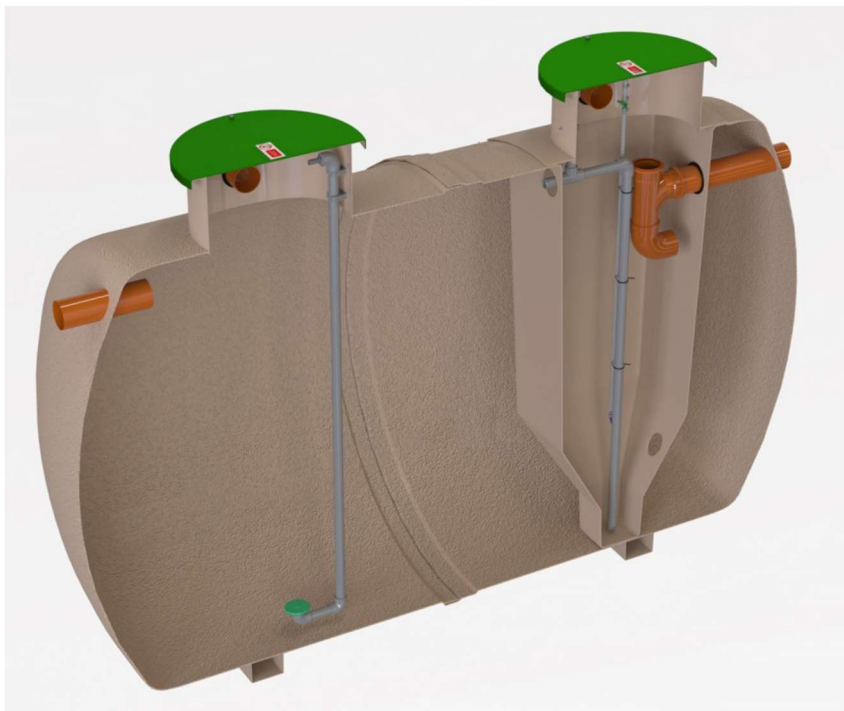

Part Code	1013819
Issue	01
Description	Initial Issue
Date	January 2024

6525

INTRODUCTION

Thank you for choosing a Clearwater product. This manual will help you to keep it operating efficiently over a long service life. Please read this manual thoroughly, preferably before installation.

This manual should be referred to by:

- The installer
- The electrician
- The service engineer.
- The maintenance engineer.
- The desludge contractor
- The owner/user

TECHNICAL DATA

Unit	BioAir 4	BioAir 6	BioAir 7	BioAir 8
Length (mm)	3238	4400	5550	7400
Width (mm)	1920	1920	1920	1920
Inlet Invert depth (mm)	500-2000	500-2000	500-2000	500-2000
Depth below ground (mm)	2245-3745	2245-3745	2245-3745	2245-3745
Blower	JDK100	JDK150	JDK 200	JDK250
Alternative Blower	LA-100A	LAM-150	LAM-200	N/A
Integral Discharge Pump* rating (W)	250	N/A	N/A	N/A

*Optional

Unit	BioAir4	BioAir 6	BioAir 7	BioAir 8
Max PE	12	20	25	35
Max Daily BOD (kg)	0.72	1.20	1.50	2.10
Maximum Daily Flow (m3)	1.80	3.00	3.75	5.25

All surface water must be excluded. These units should be used exclusively for the treatment of sewage from domestic properties. Contact Clearwater if your sewage results, wholly or partly, from any commercial function.

HEALTH AND SAFETY

Please read and follow for your own and others safety.

You must read these warnings carefully before installing or using the equipment. Please ensure that you have performed a risk assessment before commencing any installation. Note that the risk assessment should be performed by a person who understands the hazards of the work, and the work environment. Note that it must be *suitable and sufficient*, i.e., adequately considers risks and ensures controls in place to mitigate risks.



You must observe all-hazard labels and take appropriate action to avoid exposure to the risks indicated. Always ensure that all relevant documents are supplied with the equipment when being transferred to a new owner.

General guidelines

- Only experienced and competent person(s) should carry out the installation.
- The unit must have a *Pre-Service Agreement Inspection* by an approved engineer.
- Take care to maintain correct posture, particularly when lifting.
- Use appropriate lifting equipment when necessary.
- A qualified electrician should carry out electrical work deemed necessary.
- The covers must be kept locked.



Personal Protective Equipment (PPE)

- We recommend the use of a dust mask and gloves when cutting GRP components.
- Person(s) carrying out maintenance on the equipment should wear suitable PPE.



Maintenance and Inspection Procedures

If you wish to inspect the equipment's operation, please observe all necessary precautions as stated in your risk assessment; including those listed below.

- The power supply must be isolated at the control panel(s) before lifting the covers.
- If the equipment should run with the covers off, care must be taken to avoid contact with moving parts and electrical components or conductors.
- Once the power has been isolated, the control panel must be kept locked shut to avoid accidental reconnection while work or inspection is being carried out.

Working Area

- Ensure that the working area is adequately lit.
- Ensure that you are familiar with the safe working areas and its access and egress.
- Use only the designated access walkways.
- Do not walk on the cover or deep well safety mesh(es).
- Always keep proper footing and your balance, avoid any sharp edges, or restricted points.

Desludging

- Desludging should be carried out by a licensed waste disposal contractor holding the relevant permits to transport and dispose of sewage sludge in your region/area.

DESLUDGING

Desludging should be carried out by a licensed waste disposal contractor holding the relevant permits to transport and dispose of sewage sludge.

Do not empty the entire reactor and FST, as some biology should remain in the system to continue to work.

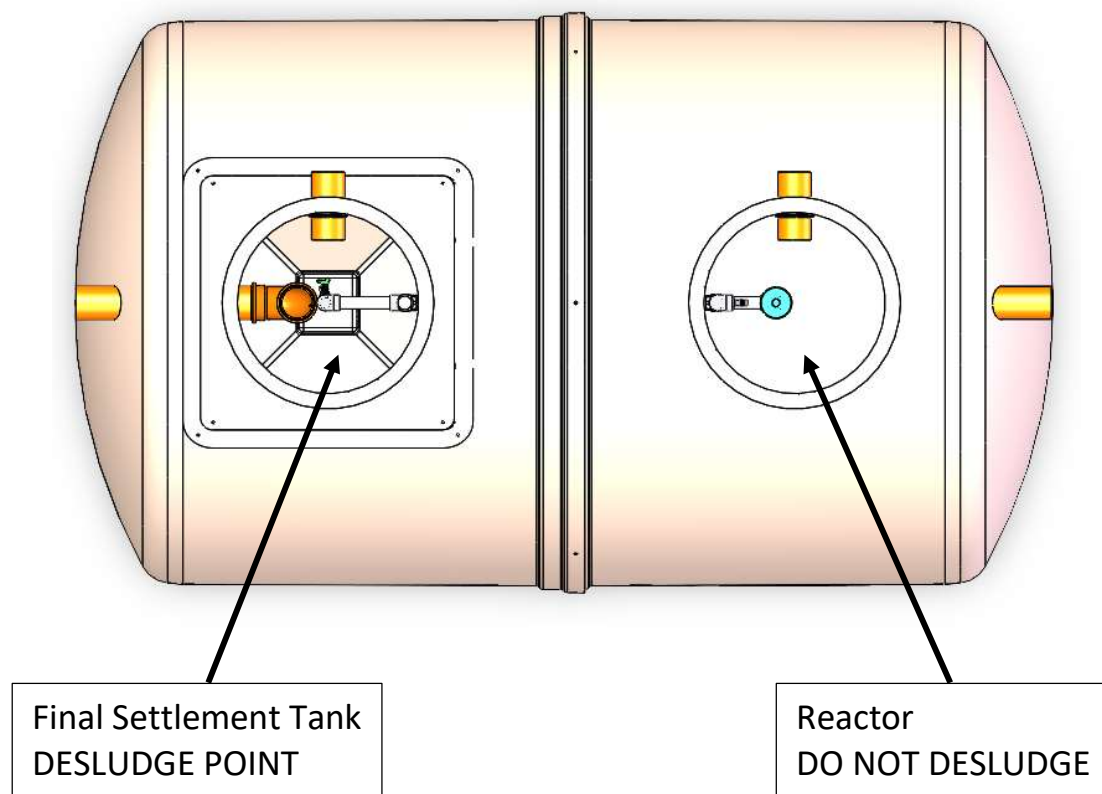

Insert the suction hose into the FST, taking care not to damage the sludge return pipework. Approximately 300mm of active sludge must remain in the bottom of the reactor.

Desludging frequency is dependent on the incoming organic load, and therefore site specific.

The final settlement tank is where humus solids settle out and are returned via the sludge return airlift to the biozone for further treatment. An amount of sludge will periodically require removing from the reactor. This is removed through the **Final Settlement Tank ONLY**, thus allowing the required amount of active sludge to remain in the reactor.

Approximate de- Sludge volumes – This table is a guide only.

Approximate Desludge Volumes				
Model	BioAir 4	BioAir 6	BioAir 7	BioAir 8
App. Desludge Volume	6220 Litres (1370 gal)	8375 Litres (1840 gal)	10960 Litres (2410 gal)	15150 Litres (3330 gal)
Desludge Period	12 Months Maximum	12 Months Maximum	12 Months Maximum	12 Months Maximum

CONTENTS

INTRODUCTION.....	2
TECHNICAL DATA	2
HEALTH AND SAFETY.....	3
DESLUDGING.....	4
CONTENTS	5
SYSTEM OVERVIEW.....	6
BioAir CHECKLIST	7
SELF HELP.....	8
DESCRIPTION AND PROCESS	9
INSTALLATION.....	10
DEEP INVERT UNITS	13
ELECTRICAL INSTALLATION	14
MAINTENANCE	18
WARRANTY	19
FAULT FINDING.....	20
NOTICE.....	21

SYSTEM OVERVIEW

Pictorial representation below indicates basic requirements for a standard system.

Cross Section

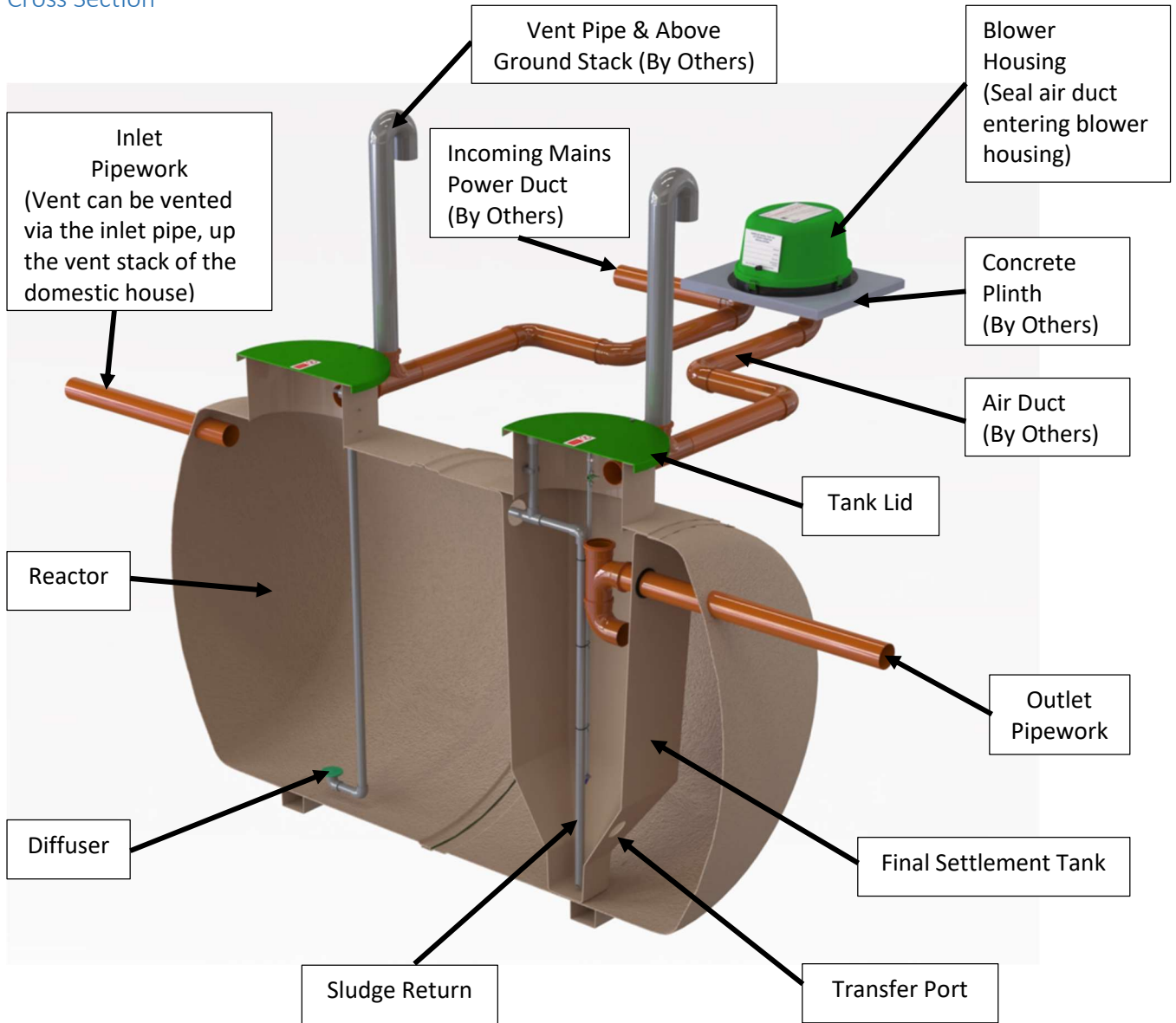

BioAir CHECKLIST

The delivery paperwork will have 2 no. items listed; check that the Tank Code (Item 1) & Blower Assembly Code (Item 2) are the same as the codes on the units delivered.

Example:

Top Level Product Code - (code)

Item 1 - (code) - (Tank Code)

Item 2 - (code) - (Blower Assembly Code)

The unit will be fitted complete with internal pipework, regulator, and equipment. Inlet pipework will be fitted.

Sewage Treatment Tank

Item 1

NB: Sewage treatment plants vary in design and volume (BioAir 4, BioAir 6, BioAir 7 & BioAir 8).

Please check your order and cross reference with relevant sales drawing.

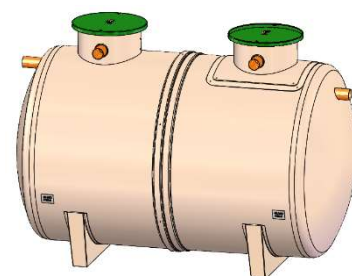

Blower Housing Assembly

Item 2

The Blower Assembly consists of the Blower Unit and associated pipework and fittings. Premium units come with control panel, beacon and the appropriate alarms. Economy versions do not come with a control panel or alarms.



19 mm Hose Coil - 15 Metres

19mm Hose required to connect from 3/4" Hose Connector in Blower Housing to Air Diffuser Manifold located within the Tank (Supplied inside Blower Housing Packaging).



13mm Hose Coil – 15 Metres

13mm Hose required to connect from 1/2" Hose Connector in Blower Housing to Sludge Return Manifold located within the Tank (Supplied inside Blower Housing Packaging).



Regulating Valve 1/2"

Pre-set the valve 60 degrees from fully open.

Fine tuning on site to achieve the minimum return flow of approximately, 3-4 Litres/minute maybe required. (Factory set. Please check settings on commissioning.)



SELF HELP

To minimize the need for dealing with emergency situations we recommend that Sewage Treatment Plants have a Pre-service Agreement Inspection, and then is regularly serviced by us or an approved Service Engineers. Provided that your plant is installed, operated correctly, and serviced, you should not need to get into much – if any – self-help. However, some of the most likely question and answer situations are listed below.

Blower Failure

Blower Stopped:

- Check the unit is switched on, the incoming power supply circuit and fuse.

Blower works but no water distribution inside the plant:

- Check hose connections.
- Check diffusers.
- If the sludge return is suspected to be blocked, call for service which number and other details you can find on the back page of this manual.
- Check regulating valve is not closed.



Plant flooding

- Check for blocked outlet system.
- If pumped outlet is all right, check for pump operation, check floats, and pump power supply.

Plant odour & Noise

- Check blower working.
- If blower working, plant probably needs desludging.
- Check vent circuit is clear.
- **Check that the air duct entering the blower housing has been sealed with foam.**
- When noisy, check the regulator valve and set as stated on page 7.

DO's



-
- Do** take out a service agreement and let the experts look after your plant.
 - Do** contact us for advice if you have any cause for concern. All contact details are at the end of this manual.
 - Do** only flush the 3 P's (Pee, Poo & Paper)

DON'TS



-
- Don't** pump feed the plant without seeking advice from Clearwater.
 - Don't** use a waste disposal unit as you will be adding to the biological load, and your system may not be large enough to cope with the waste. If you are unsure, please refer to our sales team for guidance.
 - Don't** throw any medicines down the toilet.
 - Don't** empty large quantities of bleach or similar cleaning reagents into the system.
 - Don't** empty cooking oil or similar down the sink.
 - Don't** cover the plant with soil material or prevent access for service and desludging.
 - Don't** try to enter the plant.
 - Don't** discharge backwash from Hot Tubs and Swimming Pools into the plant.
 - Don't** put sanitary towels, incontinence pads, nappies, tampons, or other non-biodegradable items down the toilet.

DESCRIPTION AND PROCESS

BioAir systems are designed to accept crude domestic sewage and produce an effluent of suitable quality for discharge to a watercourse or soak-away system, subject to the approval of the appropriate regulatory authority. BioAir systems are self-contained single piece units.

The main casing and cover of the BioAir are constructed of Glass Reinforced Plastic (GRP).

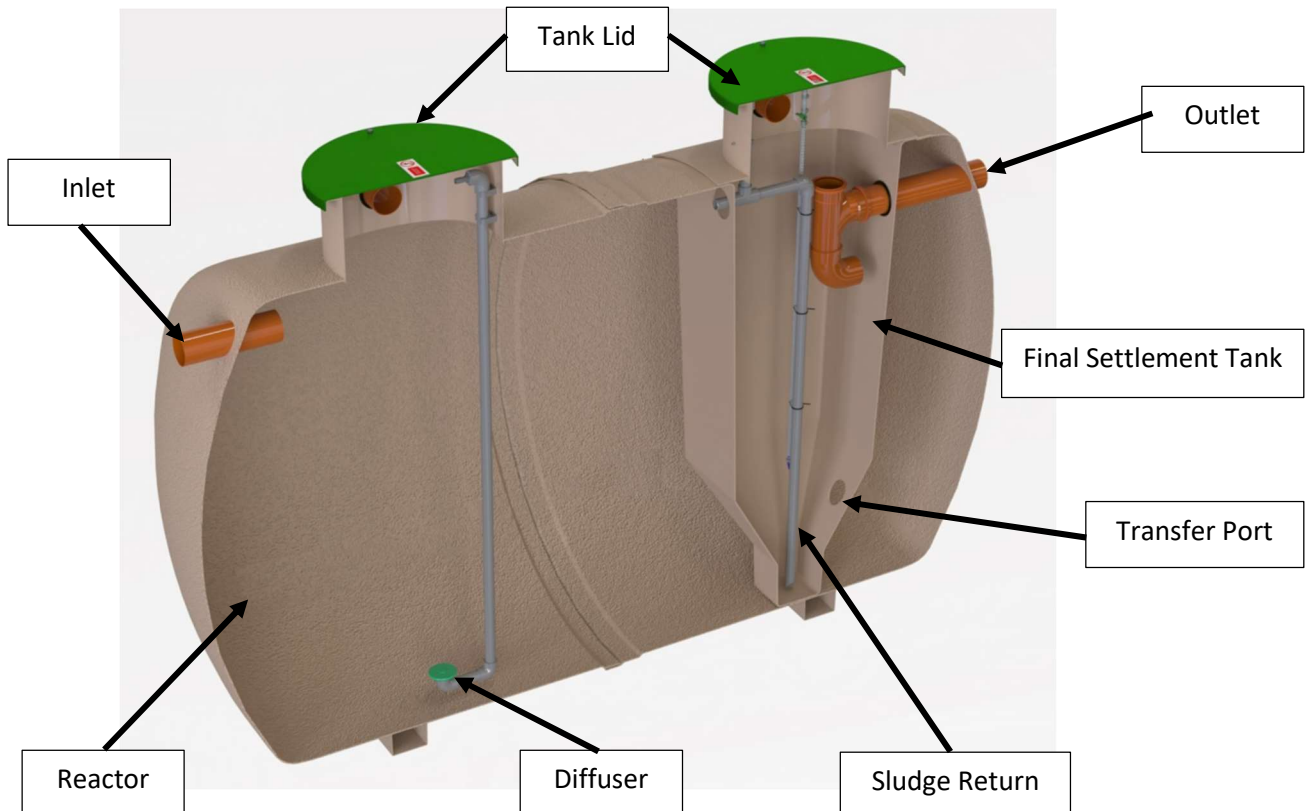

Crude sewage enters the plant through an inlet pipe in the end of the BioAir. Here, the sewage is aerated via a diffuser at the bottom of the biozone. Naturally occurring micro-organisms form part of this aerated mixture and will efficiently break down the pollutants in the sewage.

After a period of time, the aerated solids and liquids are transferred from the biozone to the FST via the transfer port. Solids will settle in the FST and will be returned to the biozone via the sludge return pipe. Treated effluent discharges from the FST through a T-pipe (except units with an Integral Discharge Pump). Periodic desludging is required when solids build up starts to impact effluent quality.

Optional Integral Discharge Pump (BioAir 4 Only)

The discharge pump sits within a Pump well, positioned in the Final Settlement Tank. Treated effluent flows into the chamber, by gravity from the FST. When the liquid in the chamber reaches a pre-determined level, a float switches on the pump which then pumps effluent out of the chamber. The same float also switches off the pump when the liquid level has been sufficiently lowered, thus protecting the pump from running dry. We do recommend when this option is purchased, that a high-level alarm is also fitted to warn against pump mal-operation or failure.

INSTALLATION

Our domestic treatment plants are structurally tested in accordance with EN 12566-3, which specifies structural stability testing for both wet and dry sites using granular backfill 3-8mm. However, in GB & IRE it would be typical for tanks to be installed in concrete due to rising water table, and it can generally be assumed that buoyancy prevention of concrete backfill is more advantageous than the granular backfill materials used in testing.

During installation, care must be taken to ensure the body of the unit is uniformly supported to avoid point loads on the unit.

A water supply must be available on site to enable the unit to be ballasted during backfilling.

When units are installed in unstable ground conditions where movement of the surrounding material and/or unit may occur, the connecting pipework must be designed to minimise the risk of damage from differential movement of the unit(s) and/or surrounding material.

In situations where the excavation will not maintain a vertical wall, it will be necessary to support the side walls of the excavation (E.g., with suitable shuttering and bracing systems) from the bottom to the top. DO NOT completely remove the shoring system until after the backfilling is complete, but before the concrete fully hardens.

If there is a risk of a high-water table or of the site flooding, a structural design by a suitable specialist will be required to hold the tank in place.

In areas where the water table is above the bottom of the excavation and/or the excavation is liable to flood, the excavation must be de-watered, using suitable pumping equipment, until the installation is complete. Ensure that the pump discharge does not saturate the ground in the immediate vicinity. In such conditions it may be advisable to line the excavation with polythene sheeting, to prevent cement being washed out of the concrete surround/base.

Concrete Specification below is a *general* specification. It is not a site-specific installation design.

GENERAL CONCRETE SPECIFICATION IN ACCORDANCE WITH BS EN 206-1 (BS 8500-1)	
TYPE OF MIX	(DC) DESIGN
PERMITTED TYPE OF CEMENT	BS 12 (OPC): BS 12 (RHPC): BS 4027 (SRPC)
PERMITTED TYPE OF AGGREGATE (coarse & fine)	BS 882
NOMINAL MAXIMUM SIZE OF AGGREGATE	20 mm
GRADES:	C25 /30
	C25 /30
	C16 /20
	REINFORCED & ABOVE GROUND WITH HOLDING DOWN BOLTS
	REINFORCED (EG. FOR HIGH WATER TABLE)
	UNREINFORCED (NORMAL CONDITIONS)
MINIMUM CEMENT CONTENT:	C30 C20
	270 - 280 Kg/M3
	220 - 230 Kg/M3
SLUMP CLASS	S1 (25mm)
RATE OF SAMPLING	READY MIX CONCRETE SHOULD BE SUPPLIED COMPLETE WITH APPROPRIATE DELIVERY TICKET IN ACCORDANCE WITH BS EN 12350-1
NOTE: STANDARD MIXES SHOULD NOT BE USED WHERE SULPHATES OR OTHER AGGRESSIVE CHEMICALS EXIST IN GROUND WATER	

1. Excavate Hole & Lay Concrete Bed

- Approximate dimensions of units:

Unit	Inlet Invert (mm)	Diameter (mm)	Unit Height (mm)	Length (mm)
BioAir 4	500-2000	1920	2245-3745	3238
BioAir 6	500-2000	1920	2245-3745	4400
BioAir 7	500-2000	1920	2245-3745	5550
BioAir 8	500-2000	1920	2245-3745	7400

- Excavate a hole with clearance on all sides and base of the unit of 150 – 200 mm, depending on site conditions.
- If shuttering is required to maintain a vertical wall, increase the width of the excavation to accommodate.
- If the excavation has an unstable base, excavate an additional 250 – 300 mm and fill with compacted hard-core.
- If water is present in the excavation, de-water using suitable pumping equipment. Place a sheet of polythene over the base and up the sides of the excavation before creating the concrete slab.
- A minimum base of 150 – 200 mm of lean mix concrete is required for all ground conditions. The installer must ensure that the base is adequate to support the weight of the tank and its contents.
- It is recommended to backfill with C25 SEMI-DRY MIX.



2. Lower Unit onto Concrete & Ensure Level

- Approximate weights of units in kilograms, depending on inlet invert:

Unit	Weight (kg)*
BioAir 4	500
BioAir 6	800
BioAir 7	1250
BioAir 8	1450

* Tank weights based on 500mm inlet invert

- Lower the tank into the hole. A suitable spreader bar must be used with lifting slings located through the lifting points provided on the tank.
- The slings must not be attached to the inlet or the outlet pipe.
- Tank must not be lifted with any water inside.
- Check the Inlet and Outlet pipe orientation is correct.
- Check the unit is levelled.

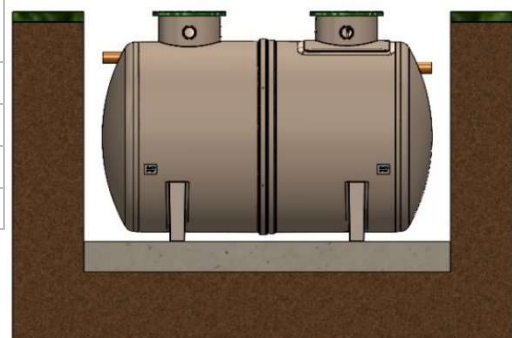

3. Backfill the Tank Unit

- The backfilling must start before the base has hardened and must be a single continuous operation, so the tank has a full concrete jacket without joins.
- The backfill must be free from organic material, large stones, brick, or sharp objects.
- Backfilling must be carried out in layers, making sure that voids are not left under or around the sides of the tank and there are no localised stress concentrations.
- The installer must progressively fill the tank via a hose while keeping the water level 300 mm above the backfill to stabilise pressures on the tank. **If the pressures are not stable the tank can become distorted and damaged.**

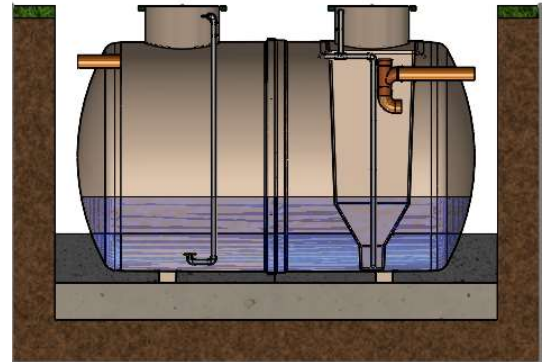

4. Second Backfill Stage

- Continue to fill the tank with water and backfill evenly around the tank, consolidating in 300 mm layers.
- DO NOT use vibrating pokers to consolidate concrete.
- DO NOT discharge concrete directly on to the tank.
- Ensure that the concrete is not too wet and that it's tamped in around the tank.
- Continue until just below inlet and outlet pipework.
- Remove covers and connect inlet and outlet pipework.
- A 110mm diameter multipurpose vent and air duct hose is located on the side of the plant. A T-piece must be connected so the unit can be vented, and the air hose connected to the blower housing.
- The vent side of the T-piece to be taken above ground and suitable vent mushroom fitted. Installer must ensure adequate venting is provided for the treatment plant to work efficiently.
- The air hose side of the T-piece to be run back to the blower housing and sealed with expanding foam to avoid foul air recirculation into the plant. The ducting for the air hose must connect through an independent concrete base for blower housing location. The duct must be laid with long radius bends to enable the hose to be threaded through.

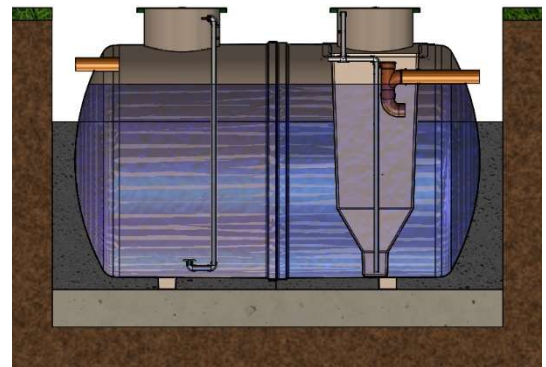

5. Final Stage

- Continue to concrete backfill up to 100 mm below the lip of the cover.
- Backfill up to lip with soil.
- Once the unit has been installed, it must be left filled with water.
- Complete electrical connections for isolator switch or control panel as shown in the electrical installation section.



DEEP INVERT UNITS

The standard units include fitted access turrets, however, for units with deeper inverts i.e., 1500 mm inlet inverts and above, additional access turret sections need to be site fitted. Before fitting the extension turrets, you must fit the extension pipes to the diffuser droppers and couple to the manifold which must be fitted into the top extension. The pumps are also supplied with extension kits that must be fitted prior to installing the neck extension. The pump cable should also be brought to the uppermost turret as installation progresses.

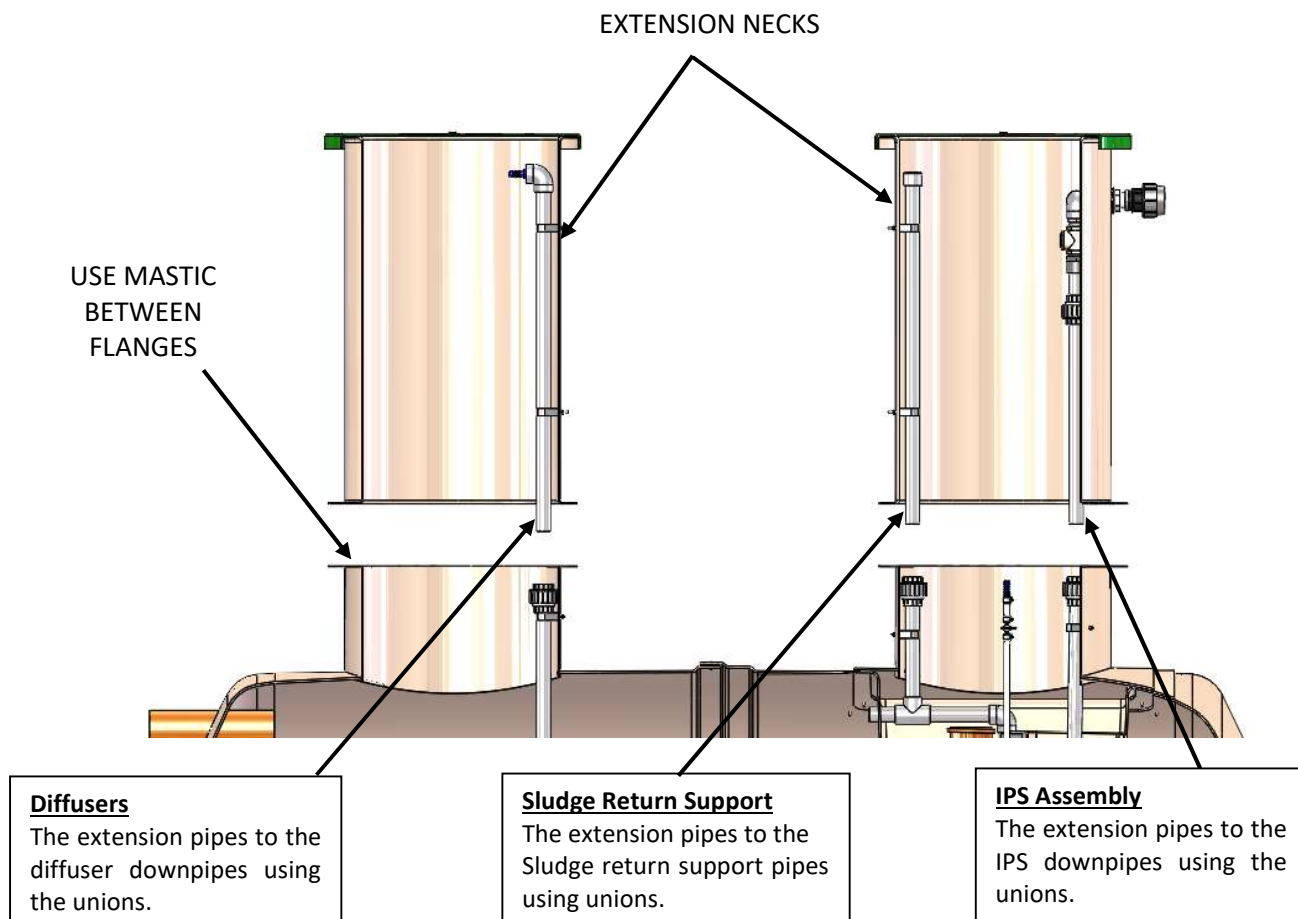

When the installation includes a separate structural concrete raft, it is necessary to order the extension kit to the full invert depth. The full invert depth is from finished ground level. Failure to take account of the finished ground level will mean that the internal valves and junction boxes will not be accessible for routine maintenance and servicing. This may require “confined space” entry which will significantly increase the cost of maintenance and servicing.

The additional turrets are flanged. Use the mastic supplied and bolt through the flanges, from top to bottom using washers below the bolt head and above the nut. Check that the flanges are fully sealed and watertight before completing the concrete backfill around each turret.

For deeper invert units (above 1000mm invert) we recommend that you temporarily strut extension turrets during this procedure to avoid distortion or collapse as the necks are non-structural.

Continue back-filling in 300mm stages, ensuring minimum 225mm concrete thickness around the access turrets.

Leave until the concrete is fully cured. The unit should be left filled with clean water up to the invert level of the outlet pipe. Check that there is a discharge.

Replace all manhole covers.

ELECTRICAL INSTALLATION

General Electrical Installation Information

Your BioAir will be supplied with an isolator switch for electrical control of the unit.

It is imperative that the electrical installation of this equipment is entrusted to a competent qualified electrician working to the latest IEE regulations.

It is not possible to state a specific installation configuration that would suit all sites. The selection of current protection devices must remain the responsibility of the installer who should select a suitable cable and current overload protection, considering the distance from the power source to the unit and any other relevant factors. (In many cases steel wire armoured (SWA) cable, minimum 1.5 sq. mm will be suitable).

When installing the electrical supply to the unit, the following points should be considered: The electric power supply to the tank should be by means of a dedicated circuit with isolation and protection devices consistent with the requirements for fixed equipment and in accordance with the latest regulations of the Institute of Electrical Engineers. This power supply should be independent of all other household protection devices other than the supply authority's main fuse and that provided specifically for the power supply. In particular, earth leakage devices provided for normal domestic protection must not form part of the supply circuit to the tank.

An earth leakage circuit breaker should be incorporated in the supply to the unit. A device with 30mA minimum trip current is recommended.

Blower Box with Isolator Switch

The Isolator with power failure light (in the blower box) can be mounted externally at a point where it is easily visible from the property.

The power supply cable should connect to the IP65 rated isolator socket mounted externally (see sales drawing). Any terminal shrouds removed during the connection of cable cores must be replaced afterwards. A separate duct or conduit should be provided by others.

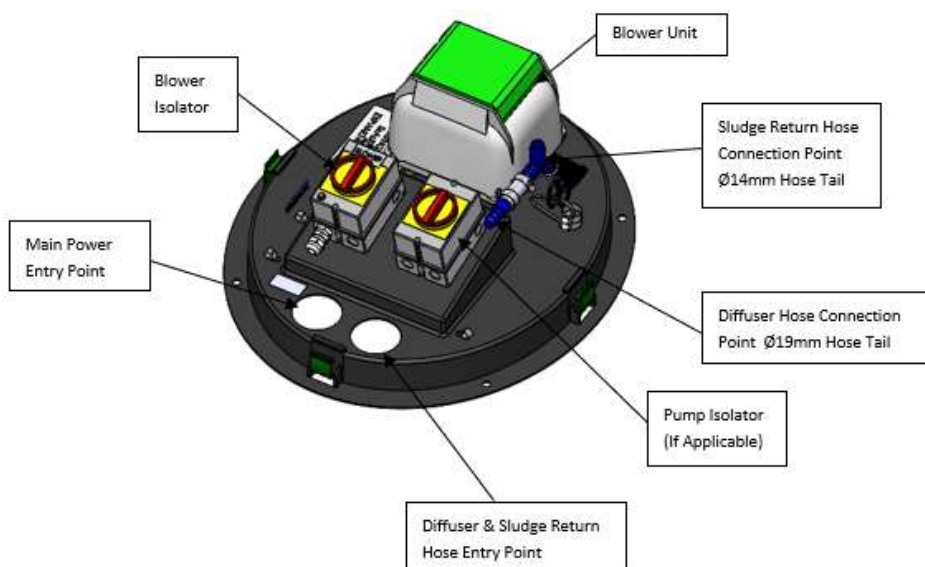

Isolator Wiring Diagram - Gravity System

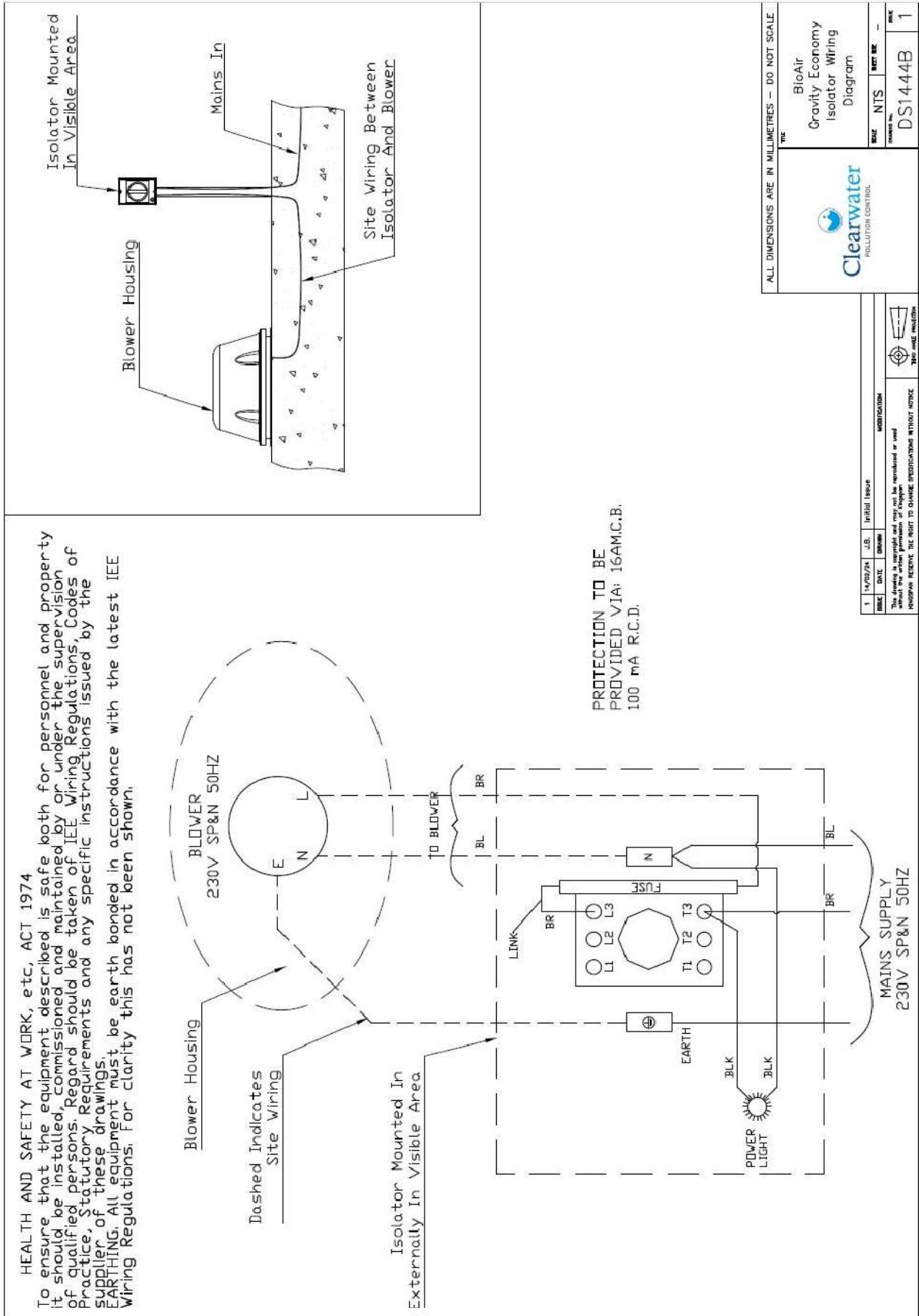

Isolator Wiring Diagram - Pumped System

HEALTH AND SAFETY AT WORK, etc, ACT 1974
 To ensure that the equipment described is safe both for personnel and property it should be installed, commissioned and maintained by or under the supervision of qualified persons. Regard should be taken of IEE Wiring Regulations, Codes of Practice, Statutory Requirements and any specific instructions issued by the supplier of these drawings.
EARTHING. All equipment must be earth bonded in accordance with the latest IEE Wiring Regulations. For clarity this has not been shown.

PROTECTION TO BE PROVIDED VIA 16 A M.C.B. 100 mA R.C.D.

NOTE:
 PUMP SUPPLIED IN TANK.
 Live @ F1 (10Amp Fuse)
 Neutral @ L1

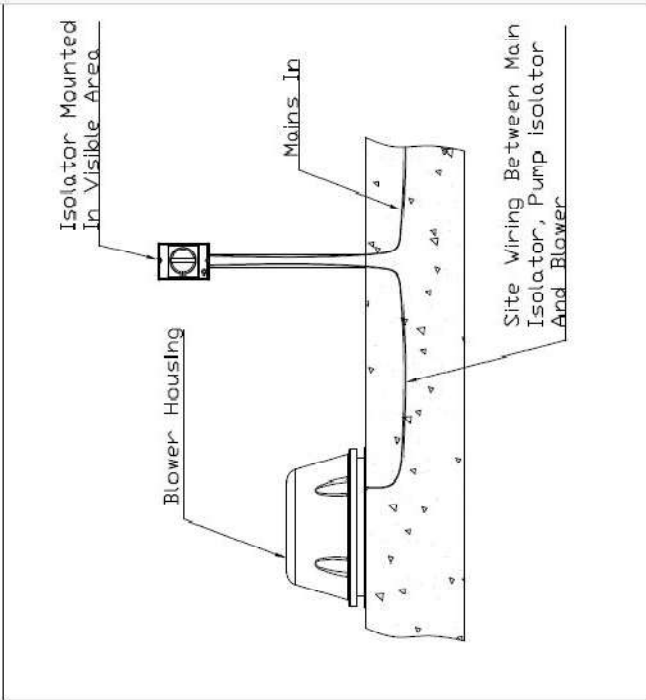
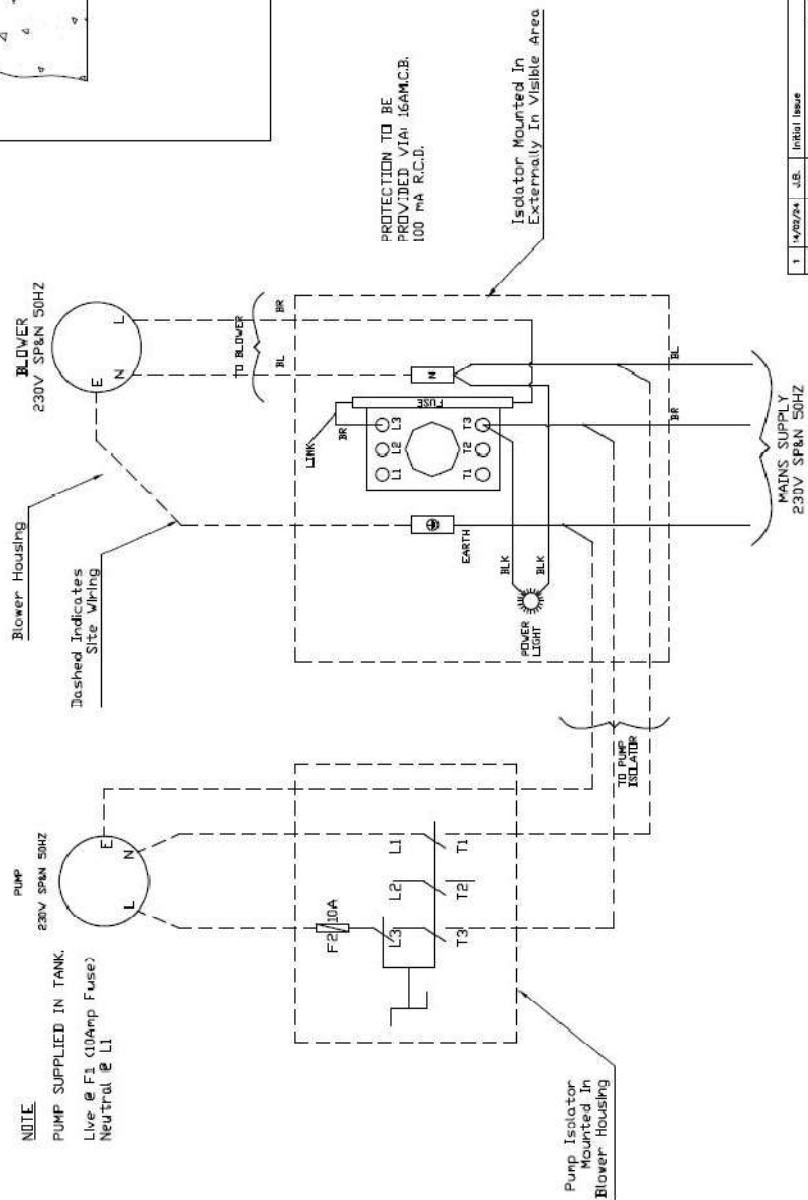

PROTECTION TO BE PROVIDED VIA 16A M.C.B. 100 mA R.C.D.

Isolator Mounted In Externally In Visible Area

Pump Isolator Mounted In Blower Housing

ALL DIMENSIONS ARE IN MILLIMETRES – DO NOT SCALE



BioAir
 IPS Economy
 Isolator Wiring
 Diagram

SCALE	NTS	REV	REC
NO			
DRAWING NO.			DS1443B
REV			1

DATE	BY	CHKD	INITIAL ISSUE	DESCRIPTION
1	14/02/24	J.B.		

The drawing is copyright and may not be reproduced or used in any form without the prior written permission of CLEARWATER POLLUTION CONTROL. CLEARWATER POLLUTION CONTROL ACCEPTS NO LIABILITY FOR LOSS OR DAMAGE TO PROPERTY OR PERSONS RECEIVING THE RIGHT TO CHANGE SPECIFICATIONS WITHOUT NOTICE.

ISO 9001 REGISTERED
 ISO 14001 REGISTERED

BioAir Blower & Duct/Vent Drawing

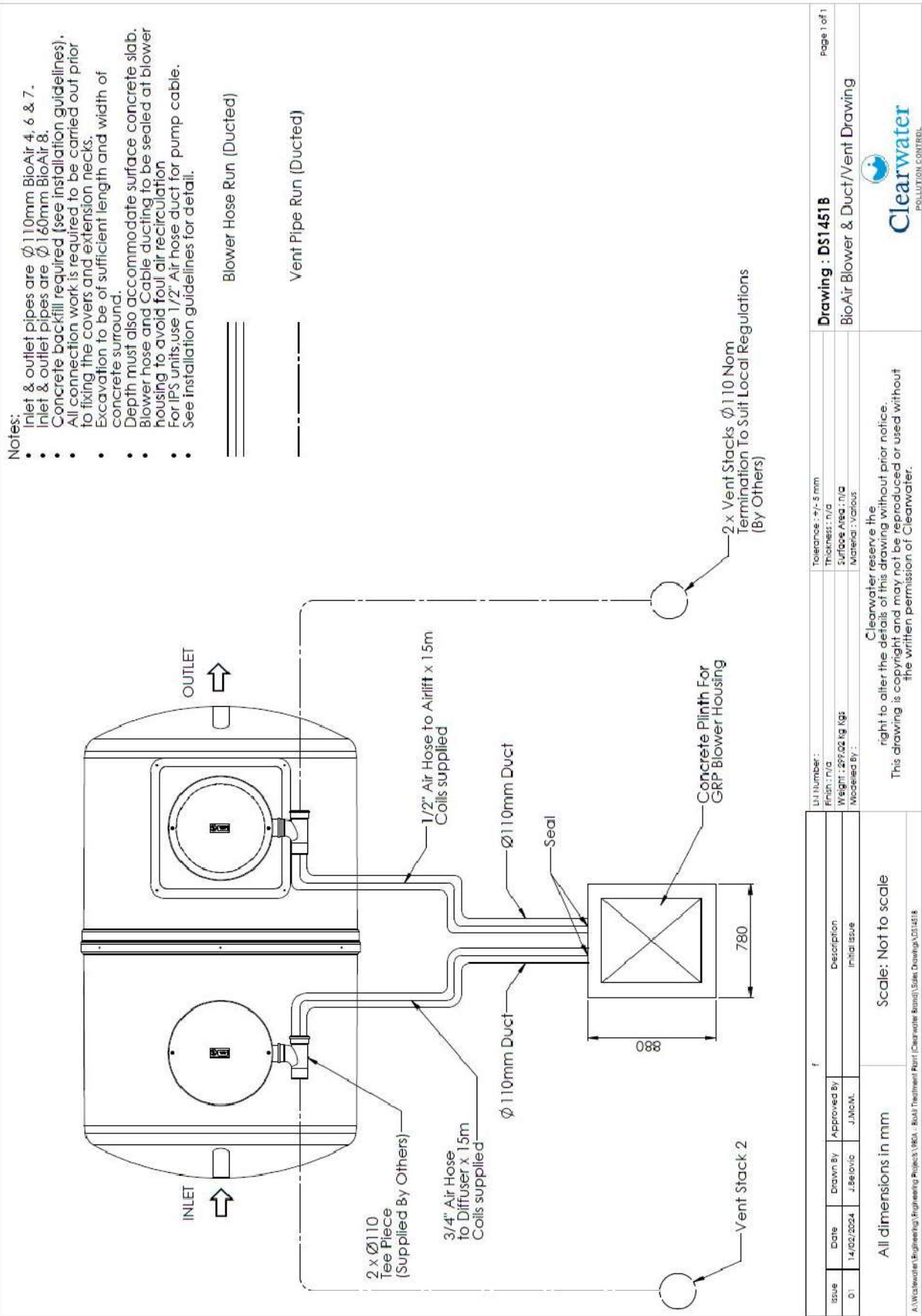

MAINTENANCE

Every sewage treatment plant needs regular maintenance as does the upkeep of drainage fields and drains. This is the responsibility of the owner/user.

We recommend that plants are maintained by qualified service personnel, however some self-help and an awareness of normal operation is helpful in identification of a larger problem.

If the plant appears not to be operating correctly, refer to the Fault-Finding section of this manual.

MAINTENANCE SCHEDULE

DAILY

Check the operation of the compressor. It should be possible to hear it running by standing close to the unit.

MONTHLY

Check the operation of the compressor (bubbles should be rising in the reactor).

Visually check that the inlet and outlet zones are clear of debris.

Odour from the plant should be 'earthy' and hydrogen sulphide odours ('rotten eggs') should not be present.

Visually check the final effluent. If cloudy or containing many suspended particles, then the humus and or primary tank is likely to require desludging.

Check the Air regulator is set correctly as stated on page 7.

THREE MONTHLY

Assess the sludge build up in the reactor and final settlement zone.

Check the blower filter and replace if necessary. Note. The filter will collect dirt particles from the air and the location of blower/inlet will influence the frequency of filter change.

TWELVE MONTHLY

The desludging frequency will be approximately 12 months.

Follow de-sludging procedure on page 4.

WARRANTY

Taken from 'Clearwater's Terms & Conditions of Sale'

The company will replace or, at its option, properly repair without charge any goods which are found to be defective, and which cause failure in normal circumstances of use within a period of twelve months from the date of delivery.

This warranty is conditional upon:

- (a) the Buyer notifying the Company of any claim within seven days of the failure becoming discernible.
- (b) the Company being allowed a reasonable opportunity to inspect the goods to confirm that they are defective.
- (c) the goods not having been modified, mishandled, or misused and being used strictly in accordance with any relevant instructions issued by the Company.

The Company's liability under this Clause is limited to the repair or replacement of the defective goods, and does not cover costs of transport, installation, or associated site costs, if applicable.

The Company's liability to replace or repair the goods is in lieu of and excludes all other warranties and conditions, and in particular (but without limitation) the Company shall have no liability of any kind for consequential loss or damage.

For any further advice, please contact us.

A Warranty Form is included in this package, to register your unit for Warranty. Please complete ALL sections of the Form and return it at your earliest convenience.

Also within this package is a Notice, describing the necessary maintenance of the plant in use. This should be fixed within the building.

FAULT FINDING

1. BLOWER NOT RUNNING

Cause

Power cut

Remedy

Do nothing. When power is restored the system will restart automatically

Check Mini Circuit Breaker on electrical supply board

Power supply RCD (Residual current Device) tripped

Isolate the power supply and reset the RCD Switch on the blower, which should start automatically If not, switch off the power and call an electrician

2. NO EVIDENCE OF AIR BUBBLES RISING THROUGH THE SLUDGE

Cause

Blower not running

Remedy

Refer to fault condition 1

Contact our Service company (Details on front cover)

3. SLUDGE NOT MOVING

Cause

Blower not running

Remedy

Refer to fault condition 1 Contact Service company

4. ODOUR

Cause

Blower not running

Remedy

Refer to fault condition 1 Contact service company

Time for a Desludge

Remove sludge from the regulator and final compartments (see desludge instructions)

NOTICE



BioAir Treatment Plant

The foul drainage from this property discharges to a Treatment Tank and an irrigation system / soak-away.

The tank requires monthly inspections of the outlet chamber or sample chamber to observe that the effluent is free-flowing and clear. The soak-away should also be inspected regularly.

The Sewage Treatment tank requires emptying at least once every 6 months (based upon plant being fully loaded) by a licensed contractor.

THE OWNER OF THE PROPERTY IS LEGALLY RESPONSIBLE FOR ENSURING THAT THE SYSTEM DOES NOT CAUSE POLLUTION, A HEALTH HAZARD, OR A NUISANCE.

We recommend that a separate log is kept of all service visits, the log should detail the date and any action taken, e.g., regular maintenance service and de-sludge volume removed.

This notice should be fixed by the owner within the building alerting current and future owners to the maintenance requirement.

Please contact Kingspan Water and Energy to arrange a maintenance service or to request replacement operating instructions.

Kingspan Water & Energy Service Contact Numbers:

GB: 0333 240 6868

NI: 028 3836 4600

IRL: 0818 543 500

Contact Details

Clearwater Pollution Control

PO Box 1035
Aylesbury
HP22 9NN

T: 0844 225 0514

F: 0844 225 0516

E: info@cwpc.co.uk

www.cwpc.co.uk

We take every care to ensure that the information in this document is accurate at the point of publication. Specification may vary (within a small parameter) due to manufacturing process variations or environmental conditions. All images are for illustration purposes only and should not be taken as binding. The actual product may vary, and specification/ dimensions/ colour/ other attributes may differ.

To ensure you are viewing the most recent and accurate product information, please visit this link: www.cwpc.co.uk

Mktg. Comp. Code (Covers only)	
02/2024_v1.6526.01	

