

TWIN VARI-RS BOOSTER SET



VARI-RS - 2RS1004/8DPT

PRODUCT OVERVIEW

The DPT Twin Vari-RS booster set is a compact and cost-effective cold water booster set ideal for residential and light commercial installations.

The Vari-RS booster set comprises of two horizontal multistage pumps and air-cooled variable speed frequency inverters with intuitive interface. The system includes a range of advanced features such as fault signals and an error code display as standard.

PRODUCT FEATURES (2RS1004/8DPT)

- Flow rate of 320 l/m (mid-curve)
- Head pressure of 3.5 bar
- Dry-run protection as standard
- Ultra quiet running
- Fully KUKReg4 Compliant
- WRAS approved pump
- WRAS approved Vessel and ballvalves
- Glycerine filled pressure gauge
- Digital display for alerts & reporting
- Air-cooled Variable speed inverter
- BMS Volt free contacts

SYSTEM OPERATION

The Twin Vari-RS cold water booster set uses the RS variable speed inverter and is installed onto the Motor Connection Box of each pump in the set. The inverter regulates the rotational speed of the pump using the electrical frequency.

The inverter operates at a minimal value that meets the users demand. In simple terms, once the pressure drops, the inverter recognises the drop in pressure and instructs the pumps to increase speed in order to meet the proportional demand.

CERTIFICATIONS & WARRANTY

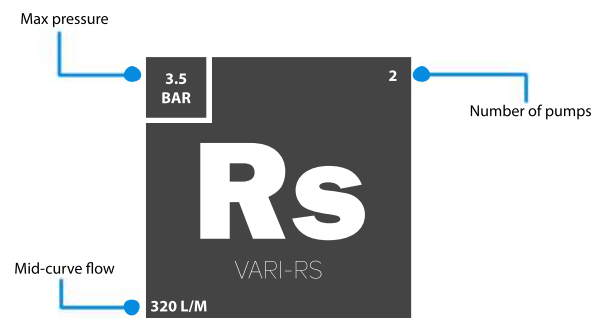

TANK OPTIONS

Direct Pumps and Tanks provide a vast array of WRAS approved cold water storage tanks, brass equilibrium ball valves, GRP enclosures for external housing of the booster system.

These enclosures can come fully insulated with encapsulated base boards for added thickness and stability and even drip trays, complete with overflow by-laws and CAT 4 (AG) or 5 (AB) air gap water protection.

VARI-RS - 2RS1004/8DPT

PUMP SPECIFICATIONS

Liquid Handled	Type of liquid	Water, moderate aggressive solutions, glycol solutions, moderate viscous fluids
	Temperature	min -15 max +85 (STD*, H**, HS** version) max +110 (-TE**, U3Q1EGG**, Q1AEGG** version)
Max chlorine content		500 ppm
Max working pressure [Mpa]		1
Construction	Impeller	Closed centrifugal type
	Motor bearings	Screened ball bearing - greased for life
Pipe Connection	Suction	2½" UNI ISO 228
	Discharge	2" UNI ISO 228
Material	Casing	EN 1.4301 (AISI 304)
	Impeller	EN 1.4301 (AISI 304)
	Intermediate casing	EN 1.4301 (AISI 304)
	O-rings	EPDM
	Shaft seal	Ceramic / Carbon / EPDM
	Liner ring	EN 1.4301 (AISI 304) +PPS
	Casing cover	EN 1.4301 (AISI 304)
	Shaft	EN 1.4301 (AISI 304) wet extension
	Bracket	EN AB-AISi11Cu2(Fe)(Die cast Aluminium)
Applicable to standard of test		ISO 9906;2012 - Grade 3B

MOTOR SPECIFICATIONS

Type	Electric - TEFC	
	Single Phase	Three Phase
Efficiency level (Reg. 1781/2019)	IE2	IE3
No. of Poles	2	
Rotation speed	2850	
Insulation Class	F	
Max temperature environment	40 Degrees C	
Protection degree (CEI EN 60034-5)	IP55	
Power rating Kw	0.45 ÷ 2.2	0.45 ÷ 4.0
Power rating HP	0.6 ÷ 3.0	0.6 ÷ 5.5
Frequency Hz	50	
Voltage	230 +10%	230/400 +10%
Capacitor	Built in	
Overload protection	Built in	Provided by user
Casing material	Aluminium	
Base material /Motor support	Aluminium	
Dimensions of cable entry	PG11 - M20X1.5	PG11 - PG13.5 M16X1.5 - M20X1.5

VARI-RS - 2RS1004/8DPT

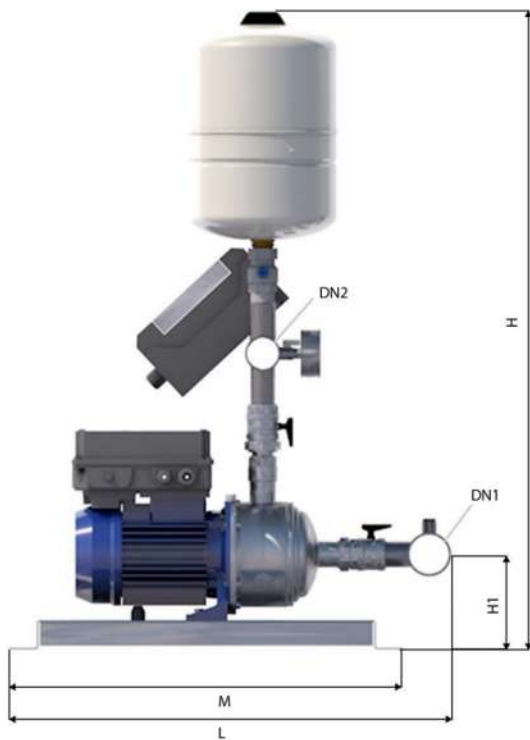

Model Ref	DN1	DN2	B	H	H1	L	M	Power Supply	Kw	HP	FLC (amp)
2RS1004/8DPT	2½"	2"	640	900	135	708	540	2x240v	2 x 1.5	2 x 2.0	2 x 6.3

Test standard: ISO 9906:2012 - Grade3B

Water; 20°C; 998.3kg/m³; 1.005cSt

