

AQUABOOST
MAB O&M MANUAL



**Please note images are representative only and may not
portray your model**



Instruction manual
Type: MAB

Execution: pressure
S-No.: _____

System controller for 1- 3 pumps

Software version 1.00 (xxx) Stand 18.12.2020



Execution: pressure control
pressure switch
limit control
limit switch
level control
level switch
temperature controller
temperature switch
volume regulator
fluid flow regulator
vacuum regulator

Option: RS485 Modus / GSM

Inverter: E600 0,75-5,5kW

content	page
1. general information about the pump regulator	3
2. safety and warning instructions	3
3. pump controller	4
4. electrical connection	5
5. first switch on - Initial setup	7
6. panel description	8
7. clock, GSM, SD-card setting	10
8. menu operation	11
9. set points menu	12
10. times menu	12
11. message menu	13
12. safety menu	14
13. transducer menu	16
14. pump / motor menu	17
15. controller menu	18
16. communication menu / phone book	18
17. system setting	20
18. cabinet setting	21
19. clear memory	22
20. pump change	22
21. zero flow shut-off	22
22. MAB Modbus register	23
23. error list	24
24. SMS commands	26
25. transducer connection 4-20mA (DST)	26
26. customer settings	26
27. Technical structure of the MAB control	27

1. General information about the pump regulator

This product complies with the latest technology and is constantly being developed and improved. The device has undergone extensive testing after manufacture and therefore functions flawlessly. To ensure optimum function, read and observe this operating manual.

2. Safety and warning instructions

Before installing and commissioning the pump regulators, please read these operating instructions carefully and observe all warning and safety instructions. Always keep this manual in easy reach near the pump regulator.

Definition



Warning !

Failure to observe the safety instructions can result in serious or even life-threatening bodily injury or substantial material damage!



Caution !

Failure to follow these instructions can result in serious or life-threatening bodily injury or material damage!



Notice !

Failure to follow these instructions may cause malfunction of the system!



The pump controller works with dangerous electrical voltages and controls dangerous rotating mechanical parts. The installation, commissioning and maintenance of this system may only be carried out by qualified personnel who are familiar with the operation. Be especially careful when automatic restart is activated. To prevent injuries due to possibly uncontrolled restarting of the motors after power failure, deactivate the automatic restart in case of doubt. During repairs or maintenance work, make sure that the system can not be switched on again by others! The built-in frequency converters have capacitors that carry dangerous high voltage even after switching off the power supply. Therefore wait at least 5 minutes after switching off the mains voltage before working on the device. Care must be taken that no live parts are touched.

Do not work on the controller,

when mains voltage is applied. Earth the motors at the connections provided for this purpose.

If the provisions of the regional energy suppliers require a residual current device, it must

the on-site RCCB for frequency converter operation is an **all-current sensitive / selective RCD (RCD) circuit breaker type: B, B + with rated current 300mA.**



Make sure that the input voltage matches the voltage entered on the nameplate. All pump regulators are tested for dielectric strength and insulation resistance. Before the insulation measurement on the pump system, z. E.g. during the inspection, the pump controller and the sensors must be disconnected!

The regulations of the electrical installation and the regional energy suppliers must be observed!

Environmental influences such as high temperatures, high humidity are to be avoided as well as dust, dirt and aggressive gases. The installation site should be well ventilated, not exposed to direct sunlight. Do not apply mains voltage to the sensor terminals or to the control terminals. Enter the operating signals Manual / 0 / Auto via the selector switch or via the control of the external contacts and not by switching on or off a mains or motor contactor. To ensure that your control system operates safely and reliably, all relevant safety regulations, such as: B. accident prevention regulations, regulations, VDE regulations, etc. are observed. Since these regulations are handled differently in the German-speaking countries, the user must observe the respective conditions applicable to him. The manufacturer can not exempt the user from the obligation to follow the latest safety regulations



The technical data and descriptions in this manual have been prepared to the best of our knowledge and belief. However, product enhancements are ongoing, so the manufacturer reserves the right to make such changes without notice. The manufacturer can not be held liable for errors in the operating instructions.

Warranty is provided within the Federal Republic of Germany and within the statutory warranty period and applies only to the product itself and not for any consequential damage or damage or cost incurred by the occurrence of a warranty claim to others. Plants or system parts arise. The operator must in any case ensure that a failure or defect of the product can not lead to further damage.

3. Pump controller

This pump controller works as pressure controller fully automatically, depending on demand.

The speed of the pump (s) is infinitely variable with frequency converter operation. The actual value in the system is determined by means of a sensor. A PI controller adjusts the actual value to the setpoint. When operating with contactor or soft starter, the pump (s) are switched on and off as required. The pump controller can be parameterized and must be adapted to the respective operating conditions. The parameters are displayed in plain text. Commissioning is menu-driven. During commissioning, some data must be entered to ensure smooth operation of the system. It should be done by a knowledgeable person.

Advantages of pump control

- almost constant control value
- Continuous adjustment of pump performance to changing operating conditions
- Energy saving in frequency converter operation
- no integrated memory required for frequency converter operation
- less mechanical wear of the pumps

Design of the pump regulation

- the pump (s) must be designed according to the plant / requirement
- the integrating memory must be properly sized and set correctly.
- The pump (s) must have hydraulic capacity (s) of 10 - 20% in order to be able to control.
- For submersible pumps, the minimum frequency must be limited to 30..35Hz (Hydrodynamic bearing) (See information from the manufacturer of the engine.
- For underwater pumps a power reduction of approx. 5..10% can be assumed

Use of GSM monitoring



If you have installed a GSM modem (terminal), you can monitor the pump controller. Depending on the technical design, different commands are available to you. Make sure the antenna is well aligned for proper wireless network connection. Make sure that the power supply is always active together with the pump regulator. You need a registered SIM card. There are 3 users allowed as phonebook entry.

Use of a Modbus data transfer



If you have installed the Modbus interface, you can monitor the pump controller or query data in the registers. Depending on the technical design, different data is available to you. You can reset the controller via the Modbus interface. There is no remote adjustment. Make sure that the power supply is always active together with the pump controller.

Installation and assembly of the controllers



Environmental influences such as high temperatures, high humidity are to be avoided as well as dust, Dirt and aggressive gases. The installation site should be a well-ventilated place not exposed to direct sunlight. Due to the heat convection, the frequency converter controller must have at least



15 cm away from side walls or other facilities. The permissible temperature range of + 5 ° C to + 30 ° C must not be fallen below or exceeded. Do not install the frequency converter controller near heat radiating equipment

Assembly of the pump control



Depending on the design of the control, a metal wall cupboard or a metal cupboard is built. The wall cabinet has 4 holes for wall mounting the control cabinet. For sole mounting stud bolts are recommended on which the control cabinet is hung. Mounting dimensions: See manufacturer data sheet The cupboard is delivered and set up with 200mm base. Pay attention to a secure position and ensure good ventilation on site. Mounting dimensions: See manufacturer data sheet

Construction of a control system with integrated storage tank (expansion tank)



A back flow preventer with spring force is absolutely necessary and can be installed in the suction line in front of the pump or in the pressure line behind the pump! If the check valve is installed in the suction line, an expansion vessel must be installed on the pressure side. Otherwise, an expansion tank can be installed if necessary. the system is operated with an expansion vessel, the expansion vessel must be pre-pressed in the unpressurised state. The prepress pressure must be checked regularly.

The height of the prepress pressure is approx. : start pressure minus 0.50 bar

Environmental conditions:



Ambient temperature: + 5 ° C - + 35 ° C
 Humidity: 0- 95% non-condensing
 Altitude: 1000m, 1% reduction / 100m
 Vibration: maximum 0.5g
 Type of protection: see type plate
 Technical data: see type plate

Construction of a pump system



A back flow preventer is mandatory and can be placed in the suction line in front of the pump or in the Pressure line to be installed behind the pump! If the back flow preventer is installed in the suction line, an integrated storage tank is required. Otherwise install an expansion vessel as required.

1 flow direction	5 back flow preventer
2 regulator	6 pressure sensor
3 Motor	7 expansion vessel
4 pump	8 template tank

Examples:

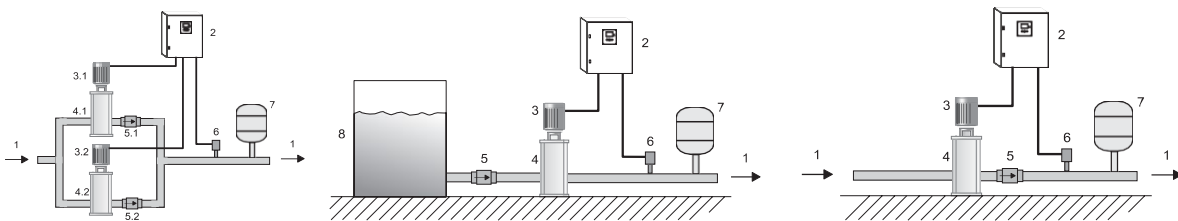

Operation of the pump system with integrated storage tank (expansion vessel)

If the system is operated with an integrated storage tank, the integrating storage tank must be pre-pressed in the unpressurised state. The prepress pressure must be checked regularly.

The height of the prepress pressure is: Starting pressure minus 0.50 bar.

Example: set start pressure: 4.00 bar
 pre-press integrating storage to: 3.50 bar

Booster systems (DEA)



Booster systems are fully cased and wired pumping systems. With them, the installation effort is minimal - connection to the existing pipe network, mains voltage and commissioning. The controller is set at the factory for these systems. These operating instructions refer only to the electrical control of the system, therefore, if necessary, consult the operating instructions of the pump (s).

4. Electrical connection of the controller



Make sure that the input voltage is on the nameplate registered voltage corresponds. Be sure to observe the supply voltage and terminal assignment!
 The installation, commissioning and maintenance of the drives may only be carried out by a person skilled in the art of pumping.



Use shielded cable! Connect the shield to the earthing clamps in the control cabinet and to the pump!
 For submersible motor pumps, connect the shield to ground potential near the pump.
 Do not apply mains voltage to the sensor or control terminals.



Do not manipulate the sensor signal!
 Do not connect other consumers to the 24V supply!
 The used sensor 4..20mA, is connected to the respective terminals!
 The respective pin assignment can be found in the wiring diagram.
 All pump regulators use 4..20mA sensors.
 The pin assignment can be found in the wiring diagram.
 If the motor cable is longer than 50 meters, it is recommended to install a motor choke / sine filter.
 Check the correct connection of the mains, sensor and control cables.

Set motor protection



The pump controller has a monitoring function for the motor current. The motor rated current when frequency converter operation is set in the menu. For designs with soft starter or contactor, the rated motor current is set on the motor protection relay or on the soft starter. See the respective operating instructions which are always enclosed with the documents.

Cable connection



The cable to the motor, the sensor cable and the cables for the external contacts must be provided with shielded cable (80%) and connected to the shielding brackets according to the opposite principle. If EMC cable glands are used, they must be connected to the screen according to the manufacturer's instructions.



Only with proper installation of the screen, a trouble-free operation is guaranteed! Umbrellas and earth are two different connections. Never use the shield as a grounding!

connection example

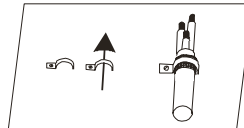

with shield bracket.

power connection



The pump regulators have a mains connection of 230 / 400V 50 / 60Hz or 230V 50 / 60Hz. See type plate of the pump regulator. Operating the controller with / without RCCB is of depending on the respective regulations. The protection takes place with fuses of characteristic C. The size of the fuse can be found on the rating plate of the pump regulator.

Digital inputs pump controller

Depending on the versions, different numbers of digital inputs are available. The digital inputs have their own potential with reference to "CO". It is used low voltage. When transferring signals from external systems, the potential must be disconnected via a relay contact. The digital inputs can be set as normally closed or normally open in the "Messages" menu and can be assigned different functions. Each function except "Reset" can only be assigned once. Functions see menu "Messages"

Digital outputs pump controller

Depending on the versions, different numbers of digital outputs are available. The digital outputs with orange terminals are floating relay outputs. The outputs may be charged with 24VDC-1A or 230VAC-1A. For signal transmission on external systems with high power, the potential must be implemented via a relay. The digital outputs can be set as normally closed or normally open in the "Messages" menu and can be assigned different functions. Each function can only be assigned once. If the total power of the controller is greater than 5.4kW, output 98 / N is always blocked for the panel fan. Functions see menu "Messages"

Digital frequency inverter outputs

For controllers with frequency inverters, depending on the version, there are different numbers of converter relays available. These relay outputs are not always routed to the terminal block. The inverter relays are potential-free and may be charged with 24VDC-1A or 230VAC-1A. For signal transmission to external systems with high power, the signal must be implemented via a relay. The inverter relays can be set as normally closed or normally open in the "Messages" menu and can be assigned different functions. Each function can only be assigned once. Functions see menu "Messages"

Analog inputs (transducer)

Depending on the versions, different numbers of sensor inputs are available. The analog inputs have their own potential. The signal is always 4-20mA. Only passive sensors with 24VDC supply can be used. If active sensors are to be used, our converter "HO.xx" must be used. For long sensor lines or for signal transfer from external systems, the signal must be disconnected via a potential converter. Each function can only be assigned once. Functions see menu "Basic" + "Sensor"

motor connection



The motor must be connected according to the output voltage. See type plate of the pump regulator. Clamp the motor on star or triangle. See nameplate of the engine. The direction of rotation of the motor determines the frequency converter. Direction of rotation can be set in the "Motor" menu.

For controls with soft starter or contactor, the direction of rotation must be adjusted by reconnecting. Depending on the design of the control, PTC thermistors can be connected. Before switching on the mains voltage again check all connections for correctness!

5. First switch on - Initial setup

Example: double system

At power-up, the controller initializes

```

MAT ▲▼
V1.xx (xx.x) SN. xxxxx
MAB
    
```

>

```

Init: (2 FU)
FU 1 : OK, old
FU 2 : OK, old
    
```

>

Main display after initialization

```

00,18 bar off P1
           off P2
           off P3
P1:□□□□ 000Hz, 00,0A
P2:□□□□ 000Hz, 00,0A
P3:□□□□ 000Hz, 00,0A
    
```

If the initialization goes wrong, there is an error message. With ER101 the frequency inverters can not be reached. Check the Modbus connection / mains voltage of the frequency inverter.

Main display error ER

```

00,18 bar ER101 P1
           ER101 P2
           ER101 P3
P1: FU ERR
P2: FU ERR
P3: FU ERR
    
```

The system is now set to "AW" = active change.

If the system setting is to be changed, this must be done in the base menu.

5.1 Switching on the system after changing the frequency inverter

Example: Double system with new INV 2

At power-up, the controller initializes

```

MAT ▲▼
V1.xx (xx.x) SN. xxxxx
MAB
    
```

>

```

Init: (2 FU)
FU 1 : OK, old
FU 2 : OK, new
    
```

>

```

INV 2 : factory setting ?
.....
    
```

Attention ! Confirm within 20s, otherwise the frequency converter will not be parameterized!

```

INV 2 : factory setting ?
.....
SET
    
```

>

```

OK !
    
```

Confirm the factory setting with the  "Set" button

Main display after commissioning.

```

00,18 bar off P1
           off P2
           off P3
P1:□□□□ 000Hz, 00,0A
P2:□□□□ 000Hz, 00,0A
P3:□□□□ 000Hz, 00,0A
    
```

6. Panel description

Control panel with four -line LCD display for parameters and operating data:



The backlight can be switched off with a delay.



The **arrow keys**

Select the functions (scrolling),
Enter / change data.



The **SET / RESET - keys**

Storing input data,
Error acknowledgment

Display with different symbols and values

Active main display with "external" / "internal" set point specification status

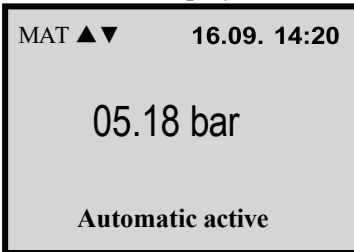

On the idle page, symbols show whether GSM or Modbus is used.

operating displays

Display: status, pressure, speed, current or active / inactive

Pumps off

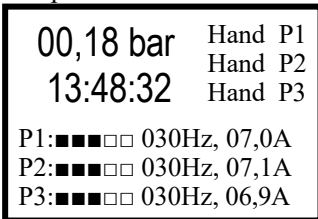

Manual operation (Hand)

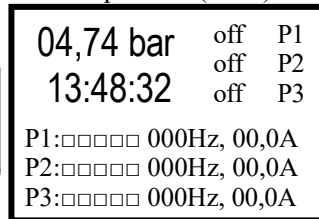

Automatic operation (Auto)

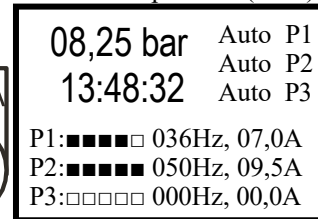

Select operating displays



With the ▲ arrow key, the next screen is displayed.

Pressing the same arrow key the next screen is displayed.

Use the ▼ arrow key, the previous screen is displayed.



If the display is "hours of operation" is displayed and the ▲ arrow key is pressed, so you get to the error memory.

From the fault memory of the SET / RESET button must be pressed to return to the initial display.

active messages

Operating Status: time, pressure, frequency, current P1-xx ... , equipment temperature

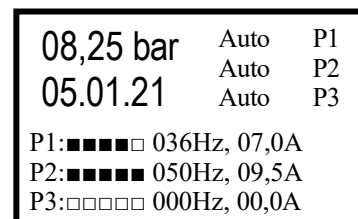
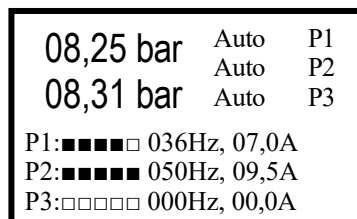
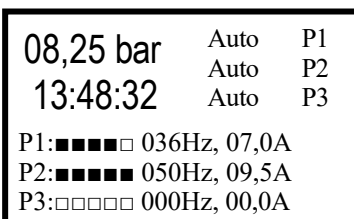

Messages

<p>08,25 bar Auto P1 13:48:32 Auto P2 Auto P3</p> <p>P1:DF 72-50 LF 065-75 29C P2:DF 99-50 LF 105-75 45C P3:DF 00-50 LF 000-75 25C</p>	<p>— Operating hours counter—</p> <p>BST P1 000:00:00 - S 000 BST P2 000:00:00 - S 000 BST P3 000:00:00 - S 000</p> <p>TLZ P1 1 000:00:00 - S 000 TLZ P2 1 000:00:00 - S 000 TLZ P3 1 000:00:00 - S 000</p> <p>Reset</p>	<p>— Fault memory—</p> <p>ER001 15-01-13 13:59 ER004 16-01-13 11:59</p> <p>_____</p> <p>_____</p> <p>_____</p> <p>Reset</p>
--	--	--

Memory status: Hour meter BST: P1-Px Memory status: day run - counter TLZ: P1-Px
 Fault memory: 1 - x with date stamp for the last 1-16 error. For each error, the pressure and pump status are stored on an extra page. Switch over by pressing the SET button for 10 seconds

Information displays

External off

The MA controller is connected via an external input. If the connection is open, the message "External off" appears. The respective pump (s) are stopped. The alarm relay is not activated

<p style="text-align: right;">external — off — —</p>
--

External low water

The MA controller is connected via an external input. If the connection is open, the message "low water" will appear. The respective pump (s) are stopped. The alarm relay switches.

<p style="text-align: right;">low — water — in 30s —</p>
--

Fill mode in active

If the "under-pressure" to be active, the MA-regulator is operated in fill mode until the pressure for the first time is balanced. The alarm relay is not activated.

<p style="text-align: right;">fill mode— active — —</p>

Safety start active

If the function "Safe Start" to be selected, the MAR controller is operated in fill mode. The master pump is active. The slave pump (s) is inactive. The alarm relay is not activated.

<p style="text-align: right;">Safety — Start — active —</p>
--

Top pressure

The current pressure is above the set upper pressure. The MA controller controls off to prevent a further rise in pressure. It appears the message "top pressure". The alarm relay is not activated.

<p style="text-align: right;">top — pressure— for 30s —</p>
--

Stopped unit

The MA-controller is connected via an external emergency stop. It appears the message "Stopped unit". The pump (s) are stopped. The red LED lights. The alarm relay switches. "Restart" via GSM or reset - function.

<p style="text-align: right;">stopped — unit — —</p>
--

7. Clock, GSM, SD-Card, Modbus set

Set time / date:

Press the **SET / RESET button** on the respective side.

Data Set and save with the help of the **arrow ▲ key, arrow ▼ key** and the **SET / RESET key**.

```
Monday      off   P1
10.01.2021  off   P2
14:52:45    off   P3

P1:□□□□□ 000Hz, 00,0A
```

```
Monday      off   P1
10.0 date    : 11.01.21 P2
14:5 time    : 14:53  P3
Su / Wi     : off

P1:□□□□□ 000Hz, 00,0A
Set. save    : no
```

```
Monday      off   P1
11.01.2021  off   P2
14:52:45    off   P3

P1:□□□□□ 000Hz, 00,0A
```

Set GSM users:

Press the **SET / RESET button** on the respective side.

Data Set and save with the help of the **arrow ▲ key, arrow ▼ key** and the **SET / RESET key**.

```
GSM: active  off   P1
signal: 20   off   P2
15,25€      off   P3

P1:□□□□□ 000Hz, 00,0A
```

```
GSM: active  off   P1
sign: user 1  : on   P2
15,2 user 2  : off   P3
user 3      : off
user 4      : on

P1:□□□□□ 000Hz, 00,0A
Set. save    : no
```

```
GSM: active  off   P1
signal: 20   off   P2
15,25€      off   P3

P1:□□□□□ 000Hz, 00,0A
```

Set SD card:

Press the **SET / RESET button** on the respective side.

Data Set and save with the help of the **arrow ▲ key, arrow ▼ key** and the **SET / RESET key**.

```
SD-card
interval : 1 Min
data: 1 .csv / 11

SD: active  frei : 3,8 GB
```

```
SD-card
remove SD-card : off
log-Interval   : 1 Min
*save data     : on

SD: active  frei : 3,8 GB
Set. save    : no
```

```
SD-card
interval : 1 Min
data: 1 .csv / 11

SD: active  frei : 3,8 GB
```

SD card messages:

Data rate: 1 min: min / 10 min / 1 hour / 10 sec.

Specification:

1/15 0 (display example)
1 / = Current file to be written to
15 = number of data written in the current file
0 = number of incorrect data

SD: Err.card (display example)

message: SD: none: no SD card inserted
message: SD: active: data is being written
message: SD: active + full: data will be overwritten
message: SD: inactive: data are not written
message: SD: Err. Card: SD card defective
message: SD: format: no DS card inserted

File: 1.csv file name and file format for evaluation in Numbers (MAC) or Excel (Microsoft)

* Set Modbus slave:

Press the **SET / RESET button** on the respective side.

Data Set and save with the help of the **arrow ▲ key, arrow ▼ key** and the **SET / RESET key**.

```
Address: 001  off   P1
Baud: 19200  off   P2
Bus inactive  off   P3

P1:□□□□□ 000Hz, 00,0A
```

```
Address: 001  off   P1
Bau Modbus RTU : on   P2
Bus set address: 001 P3
set baud rate : 19200

P1:□□□□□ 000Hz, 00,0A
Set. save    : no
```

```
Address: 001  off   P1
Baud: 19200  off   P2
Bus inactive  off   P3

P1:□□□□□ 000Hz, 00,0A
```

Between the displays operation can be changed with the arrow keys **▲** and **▼**

8. Menu operating

Set and save values

(Example set points)

setpoints
times
messages
safety
transducer
pump/motor
controller
communication
system setting
cabinet setting
*Quick setting



password	: xxx
(enter the password)	



setpoint	: 03,00bar
start difference	: 00,50bar
overrun time	: 5s

save	: no



setpoint	: 03,00bar
Start difference	: 00,50bar
overrun time	: 5s

save	: no

setpoint	: 03,90bar
start difference	: 00,50bar
overrun time	: 5s

save	: no



setpoint	: 03,90bar
start difference	: 00,50bar
overrun time	: 5s

save	: no

setpoint	: 03,90bar
start difference	: 00,50bar
overrun time	: 5s

save	: Nein

setpoint	: 03,90bar
start difference	: 00,50bar
overrun time	: 5s

save	: no



setpoint	: 03,90bar
start difference	: 00,50bar
overrun time	: 5s

save	: no



setpoint	: 03,90bar
start difference	: 00,50bar
overrun time	: 5s

save	: no



setpoint	: 03,90bar
start difference	: 00,50bar
overrun time	: 5s

save	: Yes
(save parameters)	



By pressing the - button for 5 seconds, the menu can be interrupted.

Password code: xxx



Parameter: xx.xx bar



save: Yes / No



setpoints	Code: 174
times	Code: 174
messages	Code: 174
safety	Code: 174
transducer	Code: 174
pump/Motor	Code: 174
controller	Code: 174
safety	Code: 174
communication	Code: 815
system setting	Code: 815
cabinet setting	Code: 815
adjust cabinet	Code: xxx
*Quick setting	Code: xxx

9. Adjust set-points

set points

setpoint	: 03,00bar
start difference	: 00,50bar
overrun time	: 5s

setpoint	: 03,00bar
start difference	: 00,50bar
differential value	: 00,20bar
overrun time	: 5s

setpoint	: 03,00bar
start difference.	: 00,50bar
differential value	: 00,20bar
overrun time	: 5s

setpoint 1	: 03,00bar
start difference 1	: 00,50bar
setpoint 2	: 04,00bar
start difference 2	: 00,50bar
differential value	: 00,20bar
overrun time	: 5s



The set-points are set for the plant.

Explanation of parameters:

Enter the set point which the system should work.

set point :03,00bar - 0,01bar - 99,99bar

Enter the start difference value at which the system will start again after the "Standby"

start difference :00,50bar - 0,01bar - 99,99bar

Enter the differential value at which the next pump will be switched on.

differential value :00,20bar - 0,01bar - 99,99bar

Enter the delay time until the pump to stop.

overrun time :5s - 0s - 999s

10. adjust times

times

reduction	: 0%
reduction time on	: 20:00h
reduction time off	: 23:00h
test time	: 10:00h
duration	: 20s
test interval	: 0 days



The times are set for the plant.

Explanation of parameters:

If necessary, select the pressure reduction for the pump on time.

This function gives you the possibility to reduce the energy consumption of the pump.

reduction :0% - 0 - 100 % / 0=off

reduction time on :xx:xx h - 00:00 - 23:59 h

reduction time off :xx:xx h - 00:00 - 23:59 h

Select the test run (e.g., fire extinguishing) for the pump. This feature gives you the option of running the pump once a day at hand frequency in 24 hours. This function can prevent the pump from seizing.

test time :10:00h - 00:00 - 23:59 h

duration :20s - 0 - 9999s with manual frequency

test Interval :0 days - 0 - 30 days (0 days = Off)

11. adjust messages

messages

<pre> IN01-CO-04 : EAS IN02-CO-05 : WMS INV1- 01-02 : ALS INV2- 11-12 : ALS INV3- 21-22 : ALS </pre>	<pre> IN01-CO-04 : EAS IN02-CO-05 : WMS name: low water INV1 INV2 signal NO/NC : NO INV2 delay on : 005s INV3 delay off : 005s save : no </pre>	<pre> IN01-CO-04 : EAS IN02-CO-05 : WMS name: low water INV1 INV2 signal NO/NC : NO INV2 delay on : 005s INV3 delay off : 005s save : no </pre>
---	---	---

Explanation of parameters:

digital inputs 1- 2: (4, 5)

The digital inputs are adjustable.

external inputs	:xxx	- no function
external inputs	:SIS	- setpoint I+2
external inputs	:WMS /WMO	- low water (shutdown with restart)
external inputs	:TRS /TRO	- dry run (Switch off, restart after reset)
external inputs	:HWS /HWO	- high level warning without stopping the unit.
external inputs	:EAS /EAO	- external on / off
external inputs	:RSS /RSO	- reset
external inputs	:SMS /SMO	- flow shortage
external inputs	:NAO /NAS	- Emergency stop, shutdown without restart, no SMS reset possible.

<pre> IN01-CO-04 : EAS IN02-CO-05 : WMS INV1- 01-02 : ALS INV2- 11-12 : ALS INV3- 21-22 : ALS </pre>	<pre> IN01-CO-04 : EAS IN02-CO-05 : WMS INV2-11-12 : ALS name: global alarm INV1 INV2 signal NO/NC : NO INV3 save : no </pre>	<pre> IN01-CO-04 : EAS IN02-CO-05 : WMS INV2-11-12 : ALS name: global alarm INV1 INV2 signal NO/NC : NO INV3 save : no </pre>
---	--	--

inverter relays: (INVx) (1 / 2, 11 / 12, 21 / 22)

The alarm relay frequency converter (INV) 1 to frequency converter X is adjustable.
(See frequency converter terminals)

relay INVx	: xxx	- no function (free setting directly at the INV drive)
relay INVx	:ALS / ALO	- global Alarm (NO / NC)
relay INVx	:FAS / FAO	- local Alarm
relay INVx	:WMS /WMO	- low water
relay INVx	:TRS / TRO	- dry run
relay INVx	:DMS / DMO	- low pressure
relay INVx	:HWS	- high level warning
relay INVx	:SMS / SMO	- flow shortage
relay INVx	:BES / BEO	- operating signal global
relay INVx	:LAS / LAO	- Run signal per pump

12. Setting the safety

Set the safety functions for the system

sensor limit	: on
auto reset	: off
safe start	: off
external on/off	: on
high level digital	: off
dry run digital	: off
low water digital	: off
low flow digital	: off
setpoint guard	: on
pumps guardian	: off
leakage guard	: off
runtime guard	: off

sensor limit	: on
auto dry run Hand	: on
safe dry run Auto	: on
ext message	: yes
high warning	: no
dry error	: no
low restart	: no
low SMS	: no
setp when active	: Run
pu	:
leak save	: no
ru	:

sensor limit	: on
auto dry run Hand	: on
safe dry run Auto	: on
ext message	: yes
high warning	: no
dry error	: no
low restart	: no
low SMS	: no
setp when active	: Run
pu	:
leak save	: yes
ru	:

Explanation of parameters:

Enter the sensor limit value at which the system should switch off.
If the limits are "Off", the sensor (s) are no longer monitored for <on> 20mA.

sensor limit S1	:on	- off / on
lower limit	:on	- off / on
upper limit	:on	- off / on
sensor limit S2	:off	- off / on
lower limit	:off	- off / on
upper limit	:off	- off / on
delay	:30s	- 1s - 99s

Select the reset function. In the event of a fault, this function enables an automatic restart to be started 3 times within 20 minutes.

auto reset	:off	- off / on
number of reset / 20 min	:04	- 1 - 99
delay	:30s	- 1s - 99s

If the safe start function is switched on, the Mains voltage to fill the pipeline slowly and gently. Only one works in safe start Fixed speed pump for the set time. The next pump (s) is (are) stopped.

safe start	:on	- off / on
save time	:09min	- 1min - 99min
safe frequency	:40Hz	- 0 - 200Hz

Set the digital extern on/ off function. If the corresponding digital input is activated, is switched off to „extern on/off. automatic restart is preset!

Assignment of the digital inputs is done is menu.

extern on/off Hand	:on	- off / on
extern on/off Auto	:on	- off / on
message	:yes	- no / yes
warning	:no	- no / yes
error	:no	- no / yes
restart	:no	- no / yes
SMS	:off	- off / on

Set the digital dry run protection. If the corresponding digital input is activated, is switched off to "dry run". No automatic restart is preset!

Assignment of the digital inputs is done is menu.

dry run digital Hand	:off	- off / on
dry run digital Auto	:on	- off / on
message	:no	- no / yes
warning	:no	- no / yes
error	:yes	- no / yes
restart	:no	- no / yes
SMS	:off	- off / on
when active	:Run+StBy	- Run / Run+Standby

Set the digital low high level. If the corresponding digital input is activated, is switched off to „high level". The default setting is warning without switching off!

Assignment of the digital inputs is done is menu.

high level digital Hand	:on	- off / on
high level digital Auto	:on	- off / on
message	:no	- no / yes
warning	:no	- no / yes
error	:yes	- no / yes
restart	:no	- no / yes
SMS	:off	- off / on
when active	:Run+StBy	- Run / Run+Standby

sensor limit S1	: on
lower limit	: on
upper limit	: on
sensor limit S2	: off
lower limit	: off
upper limit	: off
delay	: 030s
save	: no

auto reset	: off
reset / 20 min	: 04
delay	: 030s
save	: no

save start	: on
save time	: 09min
safe frequency	: 040Hz
save	: no

extern on/off Hand	: on
extern on/off Auto	: on
message	: yes
warning	: no
error	: no
restart	: yes
SMS	: no
when active	: Run+Stby
save	: no

dry run Hand	: off
dry run Auto	: on
message	: yes
warning	: no
error	: no
restart	: yes
SMS	: no
when active	: Run+Stby
save	: no

high level Hand	: off
high level Auto	: on
message	: on
warning	: off
error	: off
restart	: on
SMS	: off
when active	: Run+Stby
save	: no

Set the digital low water protection. If the corresponding digital input is activated, is switched off to "lack of water". Automatic restart is preset!

Assignment of the digital inputs is done in menu.

low water digital Hand	:on	- off / on
low water digital Auto	:on	- off / on
message	:no	- no / yes
warning	:no	- no / yes
error	:yes	- no / yes
restart	:no	- no / yes
SMS	:off	- off / on
when active	:Run+StBy	- Run / Run+Standby

low water Hand	: off
low water Auto	: on
message	: no
warning	: no
error	: yes
restart	: on
SMS	: off
when active	: Run+Stby
<hr/>	
save	: no

Set the digital no-flow protection. If the corresponding digital input is activated, is switched off to "lack of flow". An automatic restart is not preset!

Assignment of the digital inputs is done in menu.

low flow digital Hand	:off	- off / on
low flow digital Auto	:on	- off / on
message	:no	- no / yes
warning	:no	- no / yes
error	:yes	- no / yes
restart	:no	- no / yes
SMS	:off	- off / on
when active	:Run	- Run / Run+Standby

low flow Hand	: off
low flow Auto	: on
message	: yes
warning	: no
error	: no
restart	: yes
SMS	: no
when active	: Run
<hr/>	
save	: no

Electronic setpoint guardian Enter the % value of the setpoint monitoring for the main sensor at which the system should switch off if there is insufficient pressure. The % value refers to the set pressure value. Example: 50% of 4.0 bar. The lack of pressure is active from <2.0 bar and switches the pump off with a delay of 3 minutes. If "0%" is set, the low pressure monitoring is switched off. In addition, the electronic dry-run protection, with which the system should switch off in the event of dry-running, can be selected. If the pressure of at least 0.5 bar is not reached after 30 seconds, it is switched off due to "dry running". The dry run is also active in manual mode. No automatic restart after insufficient pressure / dry run!

setpoint guard Hand	:on	- off / on
setpoint guard Auto	:on	- off / on
control deviation target	:50%	- 1%-100%
delay	:180s	- 1s - 9999s
message	:no	- off / on
warning	:no	- off / on
error	:yes	- off / on
restart	:no	- no / yes
SMS	:off	- off / on

setpoint guard Hand	: on
setpoint guard Auto	: on
threshold	: 050%
delay	: 180s
message	: yes
warning	: no
error	: no
restart	: yes
SMS	: no
<hr/>	
dry run Hand	: on
dry run Auto	: on
threshold	: 005%
delay	: 030s
message	: yes
warning	: no
error	: no
restart	: no
SMS	: no
<hr/>	
save	: no

dry run guard Hand	:on	- off / on
dry run guard Auto	:on	- off / on
control deviation dry run	:05%	- 1%-100%
delay	:30s	- 1s - 99s
message	:no	- no / yes
warning	:no	- no / yes
error	:yes	- no / yes
restart	:no	- no / yes
SMS	:off	- off / on

The pump guardian ensures that the pump is switched off safely if the speed is too low. The function is important to protect engines. Switch on the pump monitor Always on underwater pumps.

pumps guardian	:off	- off / on
guard time	:30s	- 9s - 99s
guardian frequency	:25Hz	- 25Hz - 200Hz

pumps guardian	: off
guard time	: 030s
guardian frequency	: 30Hz
<hr/>	
save	: no

The leakage monitor ensures that the pumps are switched off safely when there are high switching frequencies in operation. Important to e.g. Protect submersible pumps from overheating. The number of starts refers to 60 minutes.

leakage guard	:off	- off / on
guard time	:60Min	- 10Min - 99Min
number of starts / 60 min	:5	- 1 - 99

leakage guard	: off
guard time	: 060Min
starts / 60 min	: 005
<hr/>	
save	: no

The maximum running time monitoring ensures the safe shutdown of the pumps for a long time Business. Important to e.g. Protect submersible pumps from overheating.

runtime guard	:off	- off / on
maximum time	:300min	- 10min - 999min
auto reset	:no	- no / yes

runtime guard	: off
maximum time	: 300min
auto rest	: no
<hr/>	
save	: no

13. Adjustment of transducer



The set points change after sensor range change !

transducer

main sensor	: S1
sensor range	: 16,00bar
main sensor offset	: 00,00bar
secondary sensor	: S3
secondary sensor Function	: off

The main sensor function is determined by the basic setting of the system.

S1= Sensor 1, S3= Sensor von FU1

off = sensor input has no function
 RD = redundant sensor works on comparison sensor S2-S1 (redundant)
 RU = redundant + auto sensor works on comparison sensor S2-S1 (redundant with switchover)

main sensor pressure 16 bar

main sensor	: S1
sensor range	: 16,00bar
main sensor offset	: 0
secondary sensor	: S3
secondary sensor Function	: off

main sensor z.B.: S1 pressure 16 bar Offset 1 bar

main sensor	: S1
sensor range	: 16,00bar
main sensor offset	: 01,00bar
secondary sensor	: S3
secondary sensor Function	: off

Explanation of parameters:

Enter the sensor input for the main sensor. Main sensor can be any existing sensor.

main sensor : S1 - S1 - S3 (function of the main sensor: basic setting)

Set the sensor measuring range. Data: See nameplate sensor.

sensor range :16,00 - 0,00 - 99,99

Enter the offset from the sensor.

main sensor offset :00,00 - 0,00 - 99,99

Enter the sensor input and the function for the secondary sensor. Secondary sensor can be any other existing sensor.

secondary sensor :S3 - S3 - S1

Enter the function for the secondary sensor.

secondary sensor Function :A - Sensor has no function !

main and secondary sensor Redundant

Main sensor	: S1
Sensor range	: 10,00bar
Main sensor offset	: 0
secondary sensor	: S3
secondary sensor Function	: RD
Redundant deviation	: 10%

main and secondary sensor Redundant switch over

Main sensor	: S1
Sensor range	: 10,00bar
Main sensor offset	: 0
secondary sensor	: S3
secondary sensor Function	: RU
Redundant deviation	: 10%

Explanation of parameters:

The redundant function compares two sensors for deviation.

Enter the sensor input and the function for the secondary sensor. Secondary sensor can be any other existing sensor.

secondary sensor :S3 - S3 - S1

Enter the function for the secondary sensor.

If the function is set to "RD", there is a message "Sensor deviation". A shutdown of the system does not take place.

If the function is set to "RU", the secondary sensor is automatically switched over when the main sensor is defective.

secondary sensor Function :RD - RD sensor works on comparison sensor 2-1 (redundant)

secondary sensor Function :RU - RD sensor works on comparison sensor 2-1 (redundant switch over)

The secondary sensor must be identical to the main sensor from the sensor value. Data: See nameplate sensor.

Enter the permissible deviation in %.

Redundant deviation :10% - 0% - 100%

14. Set electric pump / electric motor

pump / motor / INV

Read inverter	:	P1
rotating direction	:	R
acceleration time	:	02,0s
deceleration time	:	02,0s
rated current	:	008,0A
rated voltage	:	400V
rated frequency	:	050Hz
min frequency	:	020Hz
max frequency	:	050Hz
hand frequency	:	035Hz
Characteristic	:	C
Boost	:	04%
carrier frequency	:	5000Hz
PTC	:	off

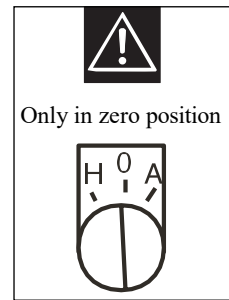

Explanation of parameters:

Select whether you want to read the data from the respective frequency inverter.

read inverter :P1 - P1 / P2 / P3

Enter the rotation direction of the pump (s). AC phase angle does not matter!

rotating direction :R / L - right / left

Enter the Acceleration time of the pump (s). Recommendation: 1-3 seconds.

acceleration time :02,0s - 0,01s - 99,9s / only manual operation

Enter the deceleration time of the pump (s). Recommendation: 2-10 seconds.

deceleration time :02,0s - 0,01s - 99,9s / only manual operation

Enter the motor rated current of the pump (s). Data: See nameplate.

rated current :xxx,0A - 0,01A - xxx,x A

Enter the motor voltage to the pump (s). The setting they found on the nameplate of the motor.

rated voltage :400V - 200V - 480V

Enter the rated frequency of the pump (s). Data: See nameplate. With this function, the nominal frequency of the pump is set.

rated frequency :50Hz - 1Hz - 200Hz

Enter the minimum frequency of the pump (s). This feature gives you the option of the minimum frequency of the pump for operation entered. This way of setting the pump power can be limited.

min frequency :20Hz - 1Hz - 200Hz

Enter the maximum frequency of the pump. This feature gives you the option to enter the maximum frequency of the pump for operation. This way of setting the pump power can be limited.

max frequency :50Hz - 1Hz - 200Hz

Enter the hand frequency in Hz, a hand, in which the respective engine in manual mode is to move up and down..

hand frequency :35Hz - 1Hz - 200Hz

Select the motor characteristic (Constant / quadratic / specific) of the pump. With this function, the power consumption of the pump can be changed. Recommendation: Square for centrifugal pumps; constant for submersible pumps; specifically at frequency inverter problems.

motor characteristic :C - Constant / quadratic / specific

Enter the value of the boost pump (s). This function is needed to better run the pump for heavy start-up.

Boost :04% - 00% - 20%

Enter the carrier frequency of the pump (s). Low carrier frequencies result in higher engine noise. This function is used to tune the carrier frequency to use with different cable lengths between pump and drive.

carrier frequency :5000Hz - 2000Hz - 9999Hz

Select the PTC thermistor function. (DI2 - CO)

PTC / thermistor :off - off / on

15. adjust controller

controller

PID P gain	: 0,50
PID-I time	: 0,50s
testing phase	: 050%
switch-on delay	: 02s
switch-off delay	: 02s
switchover time	: 05s
pump changeover time	: 300min
standby	: on
top value difference	: 100%
top value	: 15%
top value time	: 20s
load factor	: 050%
speed factor	: 050%
switch-off frequency	: 035Hz



The rule values are set for the plant

Explanation of parameters:

Enter the PID P gain of pressure control. Ensures the rapid adjustment of the pump to the desired value.

PID P gain :0,20 - 0,01 - 9,99

Enter the integration time of the PID controller. Ensures the rapid adjustment of the pump to the desired value.

PID-I time :0,50s - 0,1s - 9,99s

Enter the Testing phase for the null sets a shutdown. Recommendation: 20%. See also "zero flow cutoff"

testing phase :50% - 1% - 99% = 0,1- 0,99bar absolute

Enter the switch-on delay time for the next pump.

switch-on delay :3s - 1s - 99s

Enter the time delay for the zero quantities shutdown.

switch-off delay :3s - 1s - 99s

Enter the changeover time for the gentle pump change a

switchover time :5s - 1s - 19s

Enter the operating time until the pump change.

pump changeover time :300min - 1min - 999min

Enter the standby function. (Stop when the controller is balancing or basic speed)

Standby :on - on / off

The top value regulates the pump down to limit the pressure increase.

The value 100% = 1 bar which is calculated on the setpoint. Adjustable from 75-999%

top value difference (ref. setpoint) :100% - 75% - 999% (0% = off)

top value :15% - 0% - 50% (0% = off)

top value time :20s - 1% - 99%

Enter the load factor for the null sets shutdown. Recommendation: 50%. See also "zero flow cutoff"

load factor :50 - 1% - 99% from Inverter

Enter the speed factor for the null sets shutdown. Recommendation: 50%. See also "zero flow cutoff"

speed factor :50 - 1% - 99% from Inverter

Enter the cutoff frequency for the zero quantities shutdown.

switch-off frequency :35Hz - 1Hz - 200Hz

16. adjust communication

SD card

SD-card	: off
Modbus	: off
GSM / users	: off

SD-card	: on
remove SD card	: off
log-Interval	: 1 min
*save settings	: off
*load settings	: off
save	: no

SD-card	: on
Modbus	: off
GSM / users	: off

Explanation of parameters:

This SD card is activated automatically when it is inserted.

SD card (active) :on - off / on

Here the SD card can be ejected properly.

Remove SD card :off - off / on

Here you set the log interval.

Log-interval :1Min - 1s - 1h.

Modbus

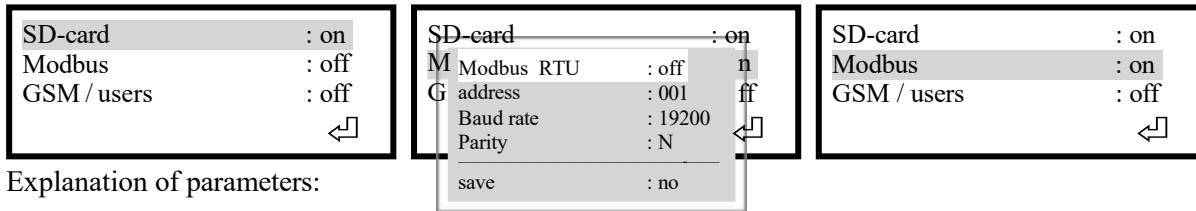

Explanation of parameters:

If data is read out, the Modbus address is set here.

The Modbus registers can be found in the Modbus appendix.

Modbus (RTU) :off - off / on

Here you set the Modbus address

Address :1 - 001 -255

The Modbus registers can be found in the Modbus appendix.

Baud rate :19200 - x-115200

The Modbus registers can be found in the Modbus appendix, see xx.x.

Parity :N - N / O / E

communication / Phone Book

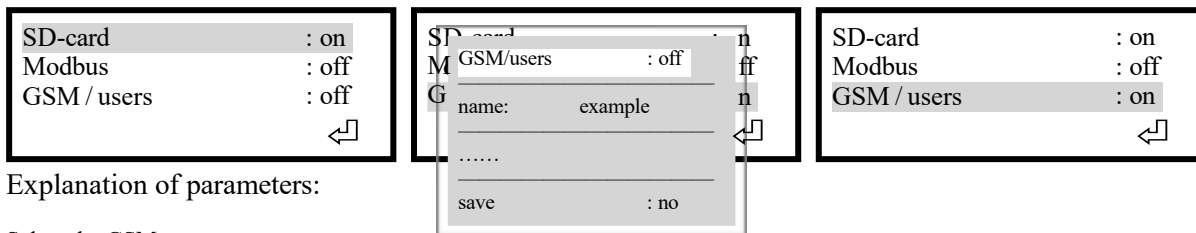

Explanation of parameters:

Select the GSM.

With this function you can monitor the system via SMS. SMS commands see xx.x.

GSM / user :off - off / on

Enter the system name and the system telephone number by overwriting a. The system reports with this name via SMS.

plant name : irrigation (e.g.)

plant number : +44150123456789 (e.g)

Switch user x "On" or "Off" and

enter the phone number of user 1-4.

If this user is "On", he is connected to the system.

user 1 (1-4) :A - From / A

Telephone number (user) : +44155123456789 (z.B.)

Change it if necessary free balance inquiry - phone number.

credit: : *100# (Germany)

Select the SIM card contract type.

Contract type :Prepaid / contract

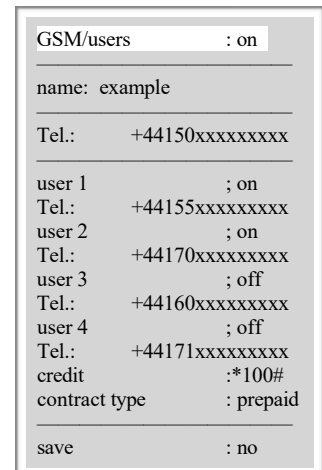

Enter the PIN for a new calling card.

The SMS command list can be found in the attachment GSM, see xx.x.

To set the system name or phone number, press **SET / RESET button** on the ad. Use the **arrow key ▲ button**, **arrow key ▼ button** and the **SET / RESET button** to change the letters or numbers. After confirming "OK", the change is accepted and the cursor jumps to the next field. To complete the name or phone number you provide a "!" And press „OK". Now they can use the **arrow key ▼ button** to the next user or go to the end. All values are only active when they are stored in the "Communication" menu.

Select these characters and numbers in circles: **AB...YZ...ab...yz... 0123456789...+*#...<.!..AB...YZ...**

Special function: **⌫** = delete

Special function: **⏎** = finish

Enter phone number Example:

Station number: number 1 is selected and confirmed with "OK".

+44**1**

Station number: number 5 is selected and confirmed with "OK".

+441**5**

Station number: delete "<" is selected and the number "5" is deleted.

+4415**⌫**

Station number: number 6 is selected and confirmed with "OK".

+4415**6**

...

Station number: End "!" Selected to complete the entry

+441621234578**!** and confirm with "OK".

Station number: entry ended.

+441621234578 name and other users can be set as well.

17. System setting

Base setting

number INV	:	3
INV 1	:	AW
INV 2	:	AW
INV 3	:	AW
operating mode	:	DR

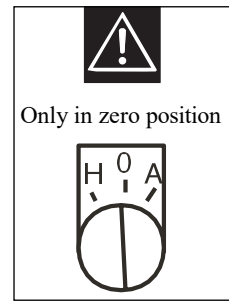

3xINV AW-AW-AW

number INV	:	3
INV 1	:	AW
INV 2	:	AW
INV 3	:	AW
operating mode	:	DR

3xINV AW-AW-BO

number INV	:	3
INV 1	:	AW
INV 2	:	AW
INV 3	:	BO
operating mode	:	DR

3xINV AW-PW-PW

number INV	:	3
INV 1	:	AW
INV 2	:	PW
INV 3	:	PW
operating mode	:	DR

Explanation of parameters:

Enter the number of frequency converter (INV) pumps.

number INV :1 - 1 - 3

Meaning of the abbreviation:

JO	= Jockey pump in the system	first pump in the system in fixed position with shutdown and transfer to the first system pump. Only selectable once.
JR	= Jockey pump in the system	first pump in the system in fixed position with shutdown,, Handover and return to the first system pump. Only selectable once.
AW	= Work pump in the system	active pump in the system with interchangeable system pump
PW	= Work pump in the system	passive pump in the system for the change pump with power limitation of the plant
AF	= Work pump in the system	active pump in the system with fixed position System pump
RF	= Work pump in the system	Reserve pump in the system as a revere for change / fix pump.
BO	= Booster pump in the system	last pump with system in fixed position with switching on and off. Only selectable once.

Depending on the version, not all operating modes can be set.

Select the operating mode of the system.

operating mode :DR - DR

DR	=	Pressure	The system works as a pressure regulator / pressure switch (bar)
TH	=	Heating	The system works as a temperature controller / temperature switch (°C)
TK	=	Cooling	The system works as a temperature controller / temperature switch (°C)
NF	=	Level filling	The system works as a level controller / level switch (cm)
NL	=	Level empty	The system works as a level controller / level switch (cm)
VR	=	Vacuum	The system works as a vacuum regulator (mbar)
ME	=	Volume	The system works as a flow regulator (l/min)
ST	=	Flow	The system works as a flow controller (%)
FU	=	frequency inverter	The system works as a motor controller with fixed or adjustable speed with external release (Hz) (rpm)

18. Cabinet setting

cabinet setting

frame	:	off
language	:	EN
factory reset	:	0
under-voltage delay	:	30s
idle screen	:	0s
fan mode	:	2
fan overrun time	:	30s
internal	:	0

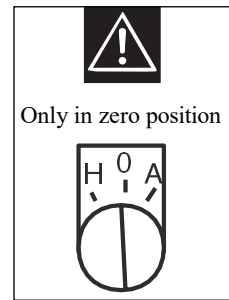

Explanation of parameters:

To the frame on the display appears around the display foil stick better (active until power "Off").

frame :0 - 0 (off) / 1 (on)

Set the menu language.

language : DE / EN - German / English

Enter the code to perform a factory reset. (Code: ask the manufacturer)

factory reset :0 - 0 „Code“

Enter the time for the under-voltage delay is to the frequency set to failure.

under-voltage delay :30s - 0 -999s

Enter the time for the idle screen

idle screen (Display) :0s - 0 -999s (0 = "off")

Adjustable fan mode, mode 0 = fan off, mode 1 = fan according to temperature, mode 2 = fan after run signal with run-on time, mode 3 = fan switched on permanently.

fan mode : 2 - 0/1/2/3

Set the fan run-on time for mode 2.

fan overrun time :30s - 0-999s

The internal menu is only accessible to the manufacturer (MAT).

internal :0 - Code

END of Menu

Internal

The "Internal" menu is only accessible to the manufacturer!

If the values for the control cabinet temperature monitoring. This function protects the cabinet from overheating.

overheating on :65°C - 55°C - 70°C (99°C=Off)
temperature warning, :55°C - 20°C - 60°C

The cabinet fan is at the set temperature and off. This function depends on prior to the frequency line.

ventilator On :35°C - 25°C - 35°C
ventilator Off :30°C - 20°C - 30°C

If the values for the control cabinet frost monitoring. This function protects the cabinet against frost or condensation.

frost warning On :3°C - 0°C - 8°C (9°C = Off)

Enter to clear the total hours of the code. (Code: Ask the manufacturer)

operating hours reset :0 - „Code“

Enter the set-point adjustment, in which the target pressure should be adjusted to the pipe.

Small 1 = target pressure drop; Larger 1 = target pressure increase.

set point adjustment :100% - 20% - 200% / 100% = off

22. MAB Modbus register

characteristics

- Baud rate: 9600, 19200, 38400, 115200
- Modbus-Address: 1-250
- Parity and stop bits:
 - a) „N“ = no parity: „8N2“ (2 Stop bits)
 - b) „U“ = Odd parity: „8O1“ (1 Stop bit)
 - c) „G“ = Even parity: „8E1“ (1 Stop bit)

Timing

- Response Time: Normal 50-200 ms (significantly longer during menu operation)
- There is a maximum answered one call per second

Reg.-Nr.	Content	Number format and encoding
994	serial number HIGH	serial number = HIGH * 216 + LOW
995	serial number LOW	For serial numbers from 0 to 65535, LOW is enough
996	P1 operating hours	
997	P2 operating hours	
998	P3 operating hours	
999	P4 operating hours	
1.000	Main sensor	Bsp.: 478 = 4.78 bar oder 478 cm oder 4.78 °C
1.001	Secondary sensor	s.o.
1.002	Error-Code	0 = no error, in case of multiple errors, only one code
1.003	switch and pump status of P1 - P4	20 =P1 Hand, 21 = P1 Auto, 22 = P1 Active, 23 = P1 Malfuct. 24 =P2 Hand, 25 = P2 Auto, 26 = P2 Active, 27 = P2 Malfuct. 28 =P3 Hand, 29 = P3 Auto, 210= P3 Active, 211= P3 Malfuct. 212=P4 Hand, 213= P4 Auto, 214= P4 Active, 215= P4 Malfuct.
1.004	Water counter 1 impulses	
1.005	Water counter 2 impulses	
1.006	P1: INV-status	0=off, 1=forward running, 2=backward running, 4–99 = error states (see error messages)
1.007	P1: INV-frequency	In 0.01 Hz, i.e. 3000= 30.00 Hz
1.008	P1: INV-current	In 0.01 A, i.e. 450 = 4.5 A
1.009	P2: INV-status	
1.010	P2: INV-frequency	
1.011	P2: INV-current	
1.012	P3: INV-status	
1.013	P3: INV-frequency	
1.014	P3: INV-current	
1.015	P4: INV-status	
1.016	P4: INV-frequency	
1.017	P4: INV-current	
1.018	Setpoint value	
1.019	Low-water threshold secondary sensor	

23. Error list



In the event of a fault, the control switches off and the pump (s) runs free. Error messages are acknowledged by an external reset input or errors are acknowledged by pressing and holding the SET / RESET key. As an option, GSM operation can be reset via SMS.

08,25 bar 13:48:32 P1: 036Hz, 07,0A	Auto P1 Auto P2 Err002 P3	08,25 bar 13:48:32 P1: 036Hz, 07,0A	Auto P1 Auto P2 Err051 P3	08,25 bar 13:48:32 P1: 036Hz, 07,0A	Auto P1 Auto P2 Err008 P3
--	---------------------------------	--	---------------------------------	--	---------------------------------

examples:

Dry-run	Error Modem	no Network
....

Error communication to external devices

The pump controller is connected via a serial connection via Modbus to an external device or the GSM modem.

If the connection is interrupted or disturbed, the pump (s) will not be stopped.

The respective error message appears in the display. The red LED lights up. The alarm relay switches.

Error modem = no connection to GSM modem

Error connection

The pump controller is connected to the frequency converter via a serial Modbus connection.

If the connection is interrupted or disturbed, the respective frequency inverter is stopped.

The display shows the error message "Er101". The alarm relay switches.

Error Modbus = no connection to the frequency converter (ER101)

Error transducer

The pump regulator is connected to the sensor via a cable. If the connection is interrupted, the error message "Sensor open" appears.

If the connection is disturbed, the error message "Sensor defective" appears.

The respective pump (s) are stopped. The alarm relay switches.

Sensor open = Sensor is not connected or faulty. If necessary, press "Reset".

Sensor defective = sensor values are outside the signal values.

Sensor deviation = sensor values are too far apart at Redundant. See menu "Sensor"

Error pressure, switching, U-pump, dry running, lack of water, motor protection

These errors are software shutdowns. Since these are common mistakes, they are displayed in plain text alternating with the error code. The respective pump (s) are stopped. The alarm relay switches.

MS = external motor protection tripped. (Operation with soft starter or contactor)

dry run = shutdown without restart. See the "Security" menu.

dow water = shutdown with restart. See the "Security" menu.

dow pressure = shutdown without restart. See the "Security" menu.

temperature warning = control cabinet becomes too hot. Improve cooling.

overheating = the control cabinet becomes too hot. Improve cooling.

PTC = thermistor triggered. Engine too hot.

external alarm = shutdown via an external input. See menu "Messages"

Error messages pump controller with frequency inverter

The error "Er001" to "Er199" are error messages. The alarm relay switches.

error Er002/5/8/16/67	: Over current, motor protection tripping. Reduce pump power. Adjust motor protection!
error Er003	: Over voltage DC link (O.E.) Mains over voltage; Check valves.
error Er004	: Phase error mains input (P.F1) phase failure. Check fuses. Check mains voltage.
error Er006	: Under voltage (L.U.) Mains voltage error. Check fuses, check mains voltage.
error Er007	: Over heating, inverter too hot. Reduce carrier frequency. Cooling defective?
error Er011	: External error ESP. Enter wrong password on the frequency converter
error Er012	: Over current in standstill. Reduce pump power. Adjust motor protection!
error Er013	: Autotuning fault ERR2. Set inverter to factory setting! Call service!
error Er015	: Error current measurement ERR4. Frequency converter defective. Exchange the FU.
error Er017	: Phase error motor (PF0) Motor phase interrupted. Check motor cable, check engine.
error Er018	: Wire break analog signal (AErr) Set inverter to factory setting! Call service!
error Er019	: Under load inverter (EP3). Engine load too low during operation. Check engine performance?
error Er020/21	: Under load inverter (EP). Engine load too low during operation. Check engine performance?
error Er022	: Sleep mode nP. Set inverter to factory setting!
error Er023	: Inverter parameter incorrect (ERR5) Set inverter to factory setting!

error Er024 : PID in standby Set inverter to factory setting!
 error Er026 : Check ground fault in cable or motor or FU (GP) wiring, drive and drive!
 error Er027 : Encoder fault. Set inverter to factory setting!
 error Er032 : Inverter parameter incorrect (PCE) Set inverter to factory setting!
 error Er035 : Fault PTC thermistor tripping (O.H1). The PTC thermistor has tripped. Improve cooling.
 error Er044 : Inverter Master-Slave error. Set inverter to factory setting!
 error Er045 : Communication error frequency converter (CE). Modbus address wrong; Check ModBus?
 error Er047 : EEPROM error in frequency converter (EEEP) Reset inverter!
 error Er049 : Watchdog error (ERR6) Check inverter settings!
 error Er050 : Inverter protection via digital input set 42. Check inverter settings!
 error Er053 : Communication error Check keypad (CE1) F930. Check setting on the FI operator part!

Error messages pump controller

error Er100 : Inverter access denied, Check inverter settings!
 error Er101 : Communication error with the frequency ; Modbus connection defective. Check connection or address
 error Er102 : Main Sensor 1 open. The sensor connection is open. Check cable connection!
 error Er103 : Error sensor 1. The sensor value is out of tolerance. .Sensor defect?
 error Er104 : Secondary Sensor 2 open. The sensor connection is open. Check cable connection!
 error Er105 : Error sensor 2. The sensor value is out of tolerance. .Sensor defect?
 error Er106 : Error sensor, check deviation between S1 + S2 set tolerance (%). Sensor defect?
 error Er107 : Error electronic pressure protection has triggered. Check setting or water inlet!
 error Er108 : Error electronic dry running protection has triggered .. Check settings or water supply!
 error Er109 : Error of external low water (WM) has triggered. Check setting or water inlet!
 error Er110 : Error of external dry run (TR) has tripped. Check setting or water supply!
 error Er111 : Error the set limit pressure has been exceeded. Check system. Set limit pressure!
 error Er112 : Error emergency stop (SMS). The plant was set to emergency stop by SMS. Reset only on the system!
 *error Er113 : Error the set lower limit has fallen below. Check system. Set limit!
 error Er114 : External an external error was triggered. Monitoring function for an external system.
 error Er115 : free
 error Er116 : Enable inverter is missing (software). Dig. Inverter input missing, defective, or not parameterized.
 error Er117 : Error modem. An error has occurred during the modem connection. Call service!
 error Er118 : Error low flow /SM). The flow has fallen below. Check system / flow limit!
 error Er119 : Error switching. The switching frequency was exceeded; Clock operation. Check valves! error
 Er120 : Error reaches maximum runtime; Leakage. Run time adjustment, or check valves.
 error Er121 : Error pump monitor has tripped. Check water consumption / check valves.
 error Er122 : Overheat cabinet (warning /shutdown). Check cooling Adjust / improve cooling.
 error Er123x : Temperature warning Sensor 2 has triggered. The message can be used for frost monitoring.
 *error Er124 : Fault PTC tripping (software). PTC has tripped. Check engine performance / cooling.
 *error Er125 : Error PT100 tripping (software). The PT100 has triggered. Check engine performance / cooling.
 *error Er126 : Error external motor protection. External motor protection tripping. Adjust motor protection!
 error Er127 : Failed main fuse failed. External fuse failure. Check main fuse!
 error Er128 : Error test run. Check system!
 error Er129 : Battery operation. Battery mode is active. Check power supply!
 error Er130 : fault chain, MAR-Master function
 error Er131 : High level (HW) warning when the level is exceeded when the level monitor is functioning.
 error Er132 : Inverter runs without enable start (DI3/\$)Dig. Inverter input is on, bridged, or not parameterized.
 .
 error Er133-179 : free
 error Er190-Er199 : SW-ERR (Call customer service!)

Error Messages GSM "Error Modem"

0 = SIM telephone book incomplete. Causes: 1. All "users" are set to "off",
 2. No valid "User" telephone number is entered
 1 = SIM lock: Enter PIN
 2 = Communication between EDS and modem interfered, received murks.
 Cause: Interference source or cable damaged?
 3 = s.o.
 4 = Problem with SIM card: No SIM inserted?
 5.6 = Signal strength interrogation (every 10 sec.) Interfered. Cause: Interference source or cable damaged?
 7 = No response to signal strength query (every 10 sec.); Modem disconnected or off?
 11 = SMS transmission failed (after 10 attempts).
 Causes: 1. Prepaid credit blank, 2nd card blocked at provider, 3. Invalid phone number on SIM
 12 = Timeout when reading or writing the SIM. One reason: too old and slow SIM or SIM removed?
 13 = Cable problem (when starting) detected: cable damaged?
 14 = Error acknowledgment from modem, cause depends on context
 15 = Communication between EDS and modem interfered, received musks.
 Cause: source of interference or cable damaged?
 16 = Modem in wrong mode. Possible cause: Modem was short-circuit-free. Solution: Re-enable GSM in the menu
 20 = "ERROR" from the modem when attempting to clean the SIM of SMS. Cause: SIM removed

24. SMS commands

SMS commands control mode "pressure, level, temperature":

commands	Send SMS → ⓘ::
Status query	STATUS
system reset	RESET
Check values	WERTE
delete values	WRESET
Log on the system	ONLINE
Log off the system	OFFLINE
system emergency stop	NOTSTOPP
Start test run	TEST



When an emergency stop is triggered, no SMS reset is possible!
The reset is only possible directly on the controller!

25. The standard pressure transducer (Danfoss) DST:

Transducer 4-20mA with M12x1 connector, 4-pin connection:

Brown (1) 24V = + supply 24VDC (86) , (84)
blue (3) = Signal Input 4-20mA (87) , (85)

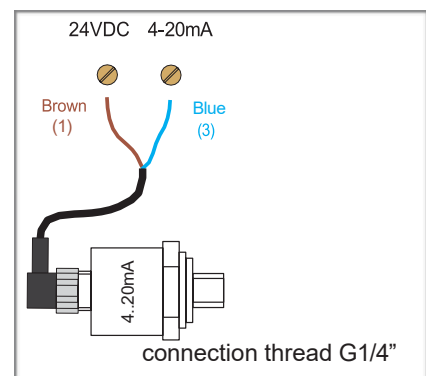

26. Customer settings

Date: _____

27. Technical structure of the MAB control

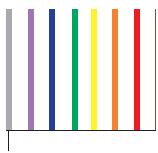
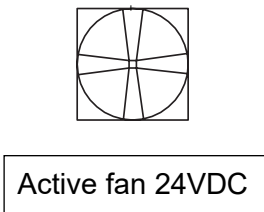
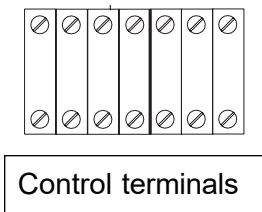
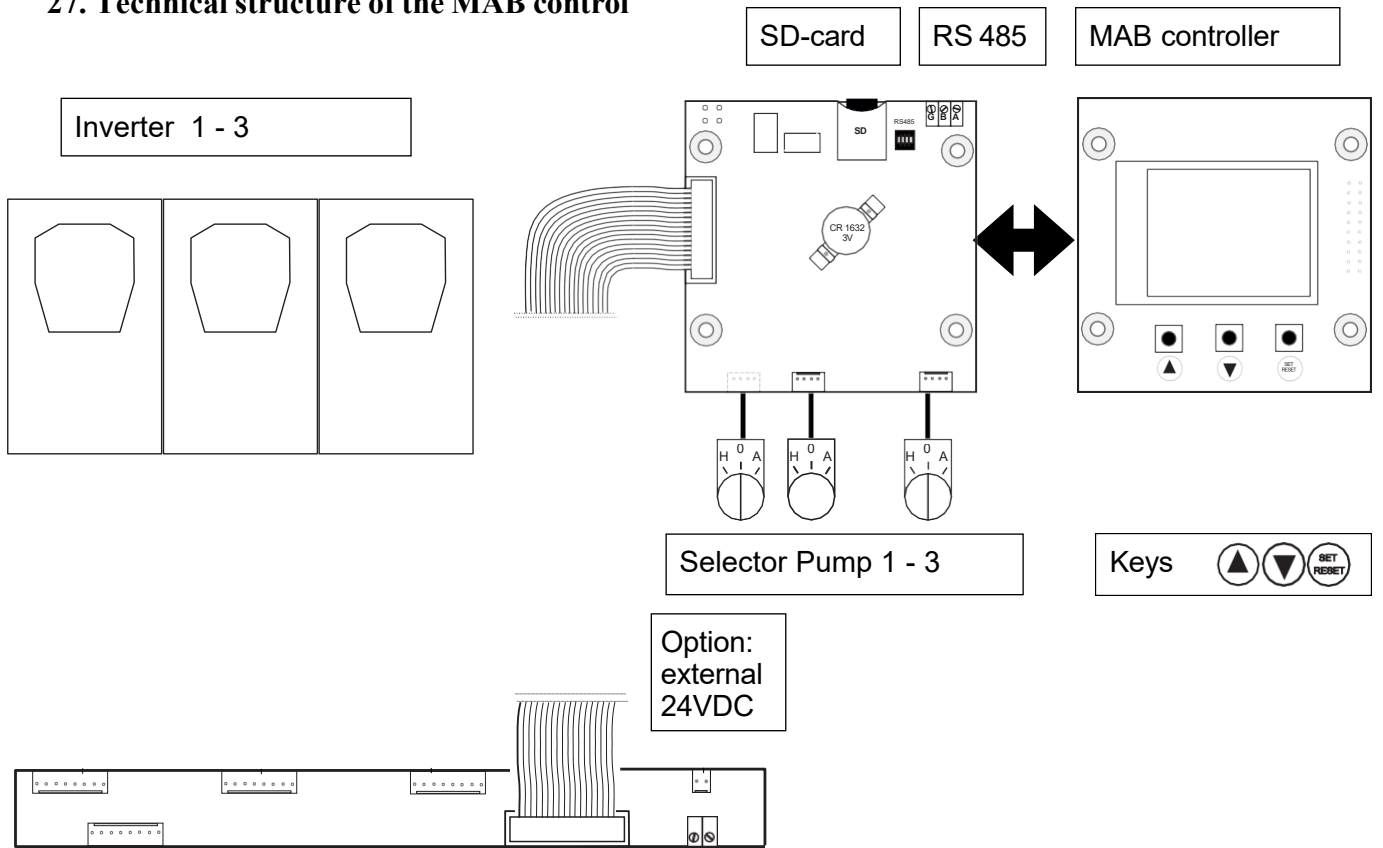

Connect inverter

GND	- gray
A	- purple
B	- blue
P24	- green
CM	- yellow
DI4	- orange
AI1	- red
AO1	- brown

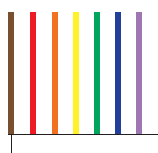

Connect terminals

○	○	Sensor 1+	- brown
○	○	Sensor 1-	- red
○	○	Sensor 2+	- orange
○	○	Sensor 2-	- yellow
○	○	CO	- green
○	○	IN4	- blue
○	○	IN5	- purple
		GND (n.c.)	- gray



Connect selector

Hand 1-3 com	- yellow
Hand 1-3 IN	- orange
Auto 1-3 com	- red
Auto 1-3 IN	- brown

Congratulations on purchasing a Stuart Turner product

We are confident this product will provide many years of trouble free service as all our products are manufactured to the very highest standard.

All MAB & MARB booster sets are warranted to be free from defects in materials or workmanship for up to 2 years from the date of purchase.

Within the warranty period we will repair, free of charge, any defects in the product resulting from faults in material or workmanship, repairing or exchanging the whole unit as we may reasonably decide.

Warranty Exclusions

Not covered by this warranty: Damage arising from incorrect installation, improper use, unauthorized repair, normal wear and tear and defects which have a negligible effect on the value or operation of the pump.

This warranty is in addition to your statutory rights as a consumer. If you are in any doubt as to these rights, please contact your local Trading Standards Department.

Warranty Claim Procedure

In the event of a claim please telephone 'TechAssist' on **+44 (0) 1977 801911** or email us at aquaboost@stuart-turner.co.uk

In the event of a claim within the terms of this warranty policy, your receipt or 'proof of purchase' provided during registration will be reviewed.

You should obtain appropriate insurance cover for any loss or damage which is not covered by Stuart Turner Ltd in this provision.

Please make a note for your own reference:

PRODUCT MODEL	SERIAL NO.	DATE PURCHASED



DECLARATION OF CONFORMITY



Supply of Machinery Regulations - 2008

EN ISO 12100:2010, EN 809:1998+A1:2009/AC:2010

Electrical Equipment Regulations - 2016

EN 60335-1:2012/A2:2019, EN 60335-2-41:2003/A2:2010

EMC Regulations - 2016

EN 55014-1:2017/A11:2020, EN 55014-2:2015, EN 61000-3-2:2014, EN 61000-3-3:2013

EMF Regulations - 2016

EN 62233:2008

RoHS Regulations - 2012

EN IEC 63000:2018

Machinery Directive - 2006/42/EC

EN ISO 12100:2010, EN 809:1998+A1:2009/AC:2010

Low Voltage Directive - 2014/35/EC

EN 60335-1:2012/A2:2019, EN 60335-2-41:2003/A2:2010

EMC Directive - 2014/30/EU

EN 55014-1:2017/A11:2020, EN 55014-2:2015, EN 61000-3-2:2014, EN 61000-3-3:2013

EMF Directive - 1999/519/EC

EN 62233:2008

RoHS Directive - 2011/65/EU

EN IEC 63000:2018

WEEE Directive - 2012/19/EU

IT IS HEREBY CERTIFIED THAT THE STUART ELECTRIC MOTOR DRIVEN PUMP AS SERIAL NUMBER BELOW, COMPLIES WITH THE ESSENTIAL REQUIREMENTS OF THE ABOVE STATUTORY REGULATIONS & E.U. DIRECTIVES.



STUART TURNER LIMITED
HENLEY-ON-THAMES, OXFORDSHIRE
RG9 2AD, ENGLAND.

RESPONSIBLE PERSON AND MANUFACTURER

Signed.....

EU AUTHORISED REPRESENTATIVE

ARC (AUTHORISED REP COMPLIANCE)
GND FLOOR, 71 LOWER BAGGOT
STREET, DUBLIN,
D02 P593, IRELAND.

Stuart Turner are an approved company to BS EN ISO 9001:2015



Stuart Turner Ltd, Henley-on-Thames, Oxfordshire RG9 2AD ENGLAND

Tel: +44 (0) 1977 801911 Fax: +44 (0) 1977 801911
info@stuart-turner.co.uk | www.stuart-turner.co.uk

Issue No. 1722-01-01