



Installation Guidance

For AquaTank, Micro, Mini, and Maxi Pump Stations

HEALTH & SAFETY

THE WARNINGS IN THIS DOCUMENT ARE PROVIDED IN THE INTEREST OF SAFETY FOR YOURSELF AND THOSE AROUND YOU. YOU MUST READ THEM CAREFULLY BEFORE INSTALLING OR USING ANY DIRECT PUMPS AND TANKS (DPT) EQUIPMENT.

DPT recommend that this document is retained with the equipment for future reference. Should the equipment be transferred to a new owner, always ensure that all relevant documents are supplied in order that the new owner can be acquainted with the equipment functionality and all relevant warnings.

INSTALLATION SHOULD ONLY BE CARRIED OUT BY A SUITABLY EXPERIENCED CONTRACTOR, FOLLOWING THESE GUIDELINES. ELECTRICAL WORK SHOULD BE CARRIED OUT BY A QUALIFIED ELECTRICIAN.

Sewage and sewage effluent can contain substances harmful to human health. Any person carrying out maintenance on the equipment should wear suitable protective clothing and take all reasonable steps to ensure safety on-site. Good hygiene practice should always be observed.

When covers are removed precautions must be taken against personnel falling into the unit. It is also recommended that you mark the working area as off-limits for the general public, land or property owner, while work is being carried out.

Should you wish to inspect the operation of the equipment, please observe all necessary precautions, including those listed below, which apply to maintenance procedures. Ensure that you are familiar with the safe working areas and accesses & that the working area is adequately lit.

Take care to maintain the correct posture, particularly when lifting. Use appropriate lifting equipment when necessary. Always keep proper footing and balance. Avoid any sharp edges.

The removal of sediment should be carried out by a contractor holding the relevant permits to transport and dispose of such waste. The contractor must refer to the guidelines in this document.

AS WITH ALL SITE WORK, THE DANGERS OF WORKING WITH WATER AND ELECTRICITY POSE SEVERE THREATS TO HEALTH, IF OBVIOUS AND FUNDAMENTAL PRECAUTIONS ARE NOT TAKEN. THEREFORE, IF YOU ARE IN ANY DOUBT REGARDING ANY OF THE FOLLOWING, PLEASE DO NOT HESITATE TO CONTACT US.

Table of Contents

AquaTank Single System Overview.....	3
AquaTank Twin System Overview.....	5
Micro System Overview.....	7
Mini/Maxi Single System Overview.....	9
Mini/Maxi Twin System Overview.....	11
Application.....	13
Maintenance.....	13
Discharge Pipework.....	13
Inlet.....	13
Cable Duct Pipework.....	14
Electrical Connections.....	14
Electrical Connection Sample Layout.....	14
Installation Considerations.....	16
Wet and Dry Site Descriptions.....	16
Delivery Handling and Storage.....	17
Installation.....	17
Example Concrete Pour and Water Ballast.....	21
Important Notes.....	24

1. AquaTank Single System Overview

The below is a visual representation of the AquaTank Single pump station with associated components. Please take time to review the pump station prior to installation.





1.1. Chamber Dig Depths

Chamber Diameter	Chamber Depth	Minimum Excavation Depth	Minimum Excavation Diameter
610mm	635mm	1035mm	910mm
610mm	1000mm	1400mm	910mm
610mm	1500mm	1900mm	910mm
610mm	2000mm	2400mm	910mm
1000mm	1000mm	1400mm	1300mm
1000mm	1500mm	1900mm	1300mm
1000mm	2000mm	2400mm	1300mm

1.2. AquaTank Package Contents

This section highlights the various components that come with the AquaTank package pump station as standard and optional extras if ordered.

Pump System Components	Image
<ul style="list-style-type: none"> 1 X MDPE Chamber 1 X DPT Pump C/W Non-Return Valve 1 X Internal Pipework 1 X 40mm Cable Duct 1 X 110mm Wall Seal 	
Optional Outlet	Image
<ul style="list-style-type: none"> MDPE 32mm Outlet Connector 	
Optional High-Level Alarm	Image
<ul style="list-style-type: none"> High-Level Alarm C/W Float Switch and Cable Glands 	

2. AquaTank Twin System Overview

The below is a visual representation of the AquaTank Twin pump station with associated components. Please take time to review the pump station prior to installation.

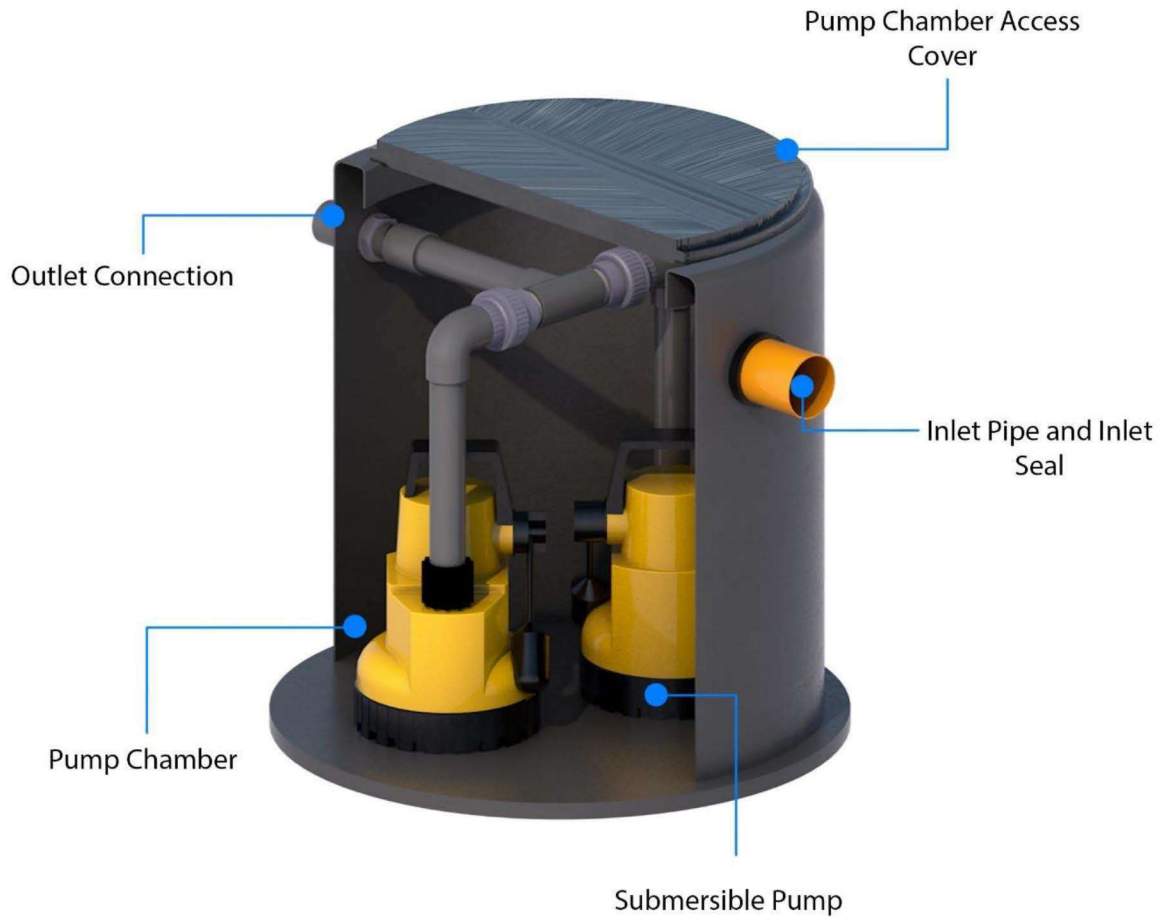

2.1. Chamber Dig Depths

Chamber Diameter	Chamber Depth	Minimum Excavation Depth	Minimum Excavation Diameter
610mm	635mm	1035mm	910mm
610mm	1000mm	1400mm	910mm
610mm	1500mm	1900mm	910mm
610mm	2000mm	2400mm	910mm
1000mm	1000mm	1400mm	1300mm
1000mm	1500mm	1900mm	1300mm
1000mm	2000mm	2400mm	1300mm

2.2. AquaTank Pro Package Contents

This section highlights the various components that come with the AquaTank Pro package pump station as standard and optional extras if ordered.

Pump System Components	Image
<ul style="list-style-type: none"> 1 X MDPE Chamber 2 X DPT Pump C/W Non-Return Valve 1 X Internal Pipework 1 X 40mm Cable Duct 1 X 110mm Wall Seal 1 X Access Cover 	
Optional Outlet	Image
<ul style="list-style-type: none"> MDPE 32mm Outlet Connector 	
Optional High-Level Alarm	Image
<ul style="list-style-type: none"> High-Level Alarm C/W Float Switch and Cable Glands 	

3. Micro System Overview

The below is a visual representation of the DPT Micro pump station with associated components. Please take time to review the pump station prior to installation.

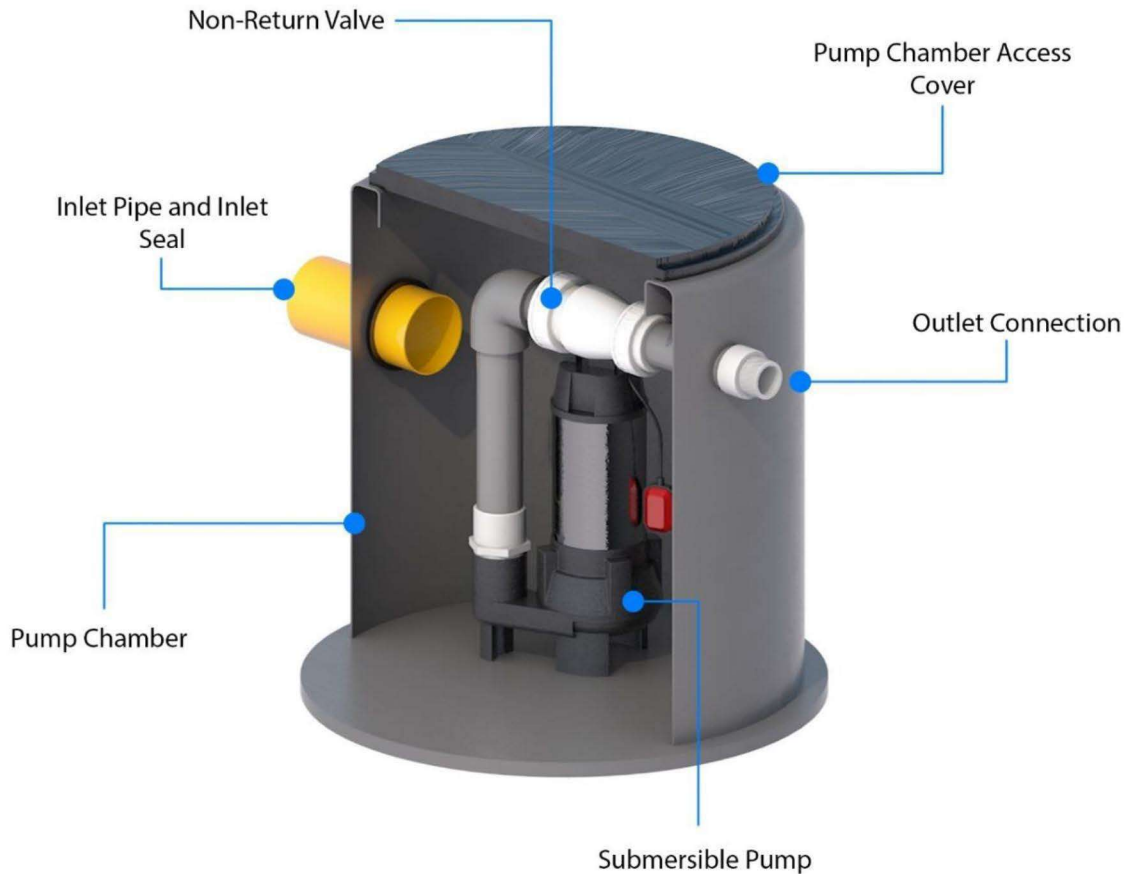



3.1. Chamber Dig Depths

Chamber Diameter	Chamber Depth	Minimum Excavation Depth	Minimum Excavation Diameter
610mm	635mm	1035mm	910mm
610mm	1000mm	1400mm	910mm
610mm	1500mm	1900mm	910mm
610mm	2000mm	2400mm	910mm

3.2. Micro Package Contents

This section highlights the various components that come with the Micro package pump station as standard and optional extras if ordered.

Pump System Components	Image
<ul style="list-style-type: none"> 1 X MDPE Chamber 1 X Pump 1 X Internal Pipework 1 X Non-Return Valve 1 X 40mm Cable Duct 1 X 110mm Wall Seal 1 X Access Cover 	
Optional Outlet	Image
<ul style="list-style-type: none"> MDPE 63mm Outlet Connector 	
Optional High-Level Alarm	Image
<ul style="list-style-type: none"> High-Level Alarm C/W Float Switch and Cable Glands 	

4. Mini/Maxi Single System Overview

Below is a visual representation of the DPT Mini and Maxi Single pump station with associated components. Please take time to review the pump station prior to installation.

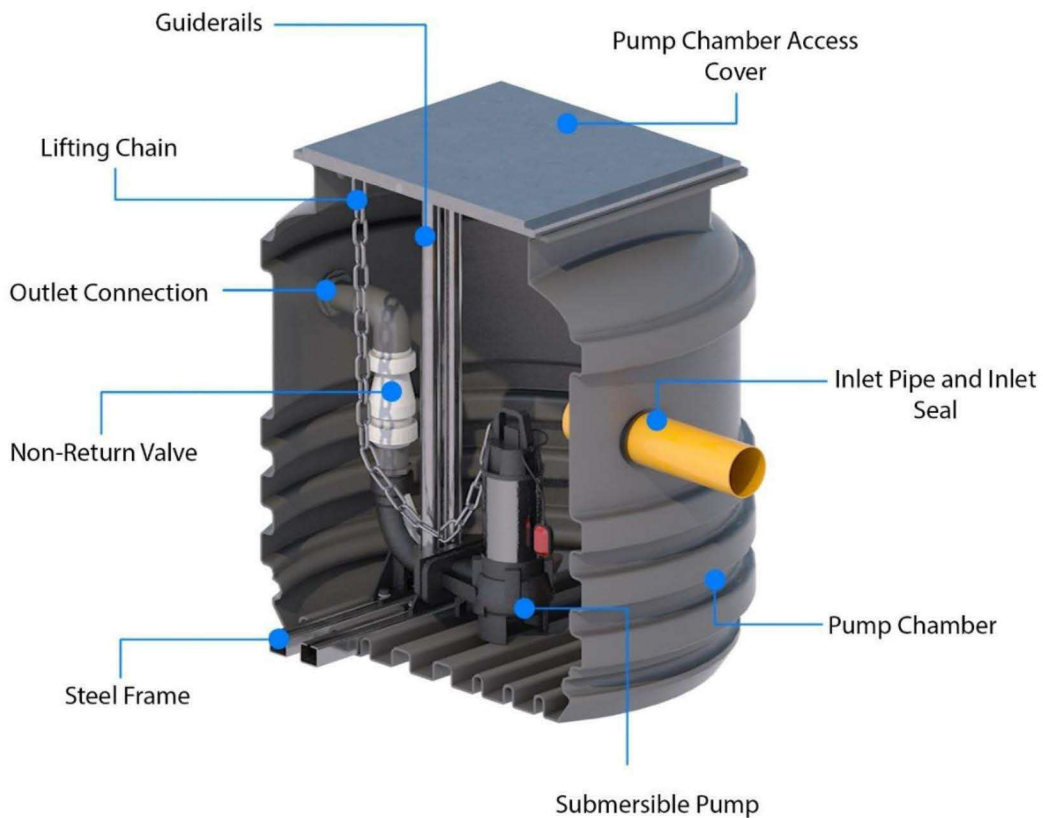



4.1. Chamber Dig Depths

Chamber Diameter	Chamber Depth	Minimum Excavation Depth	Minimum Excavation Diameter
1000mm	1000mm	1400mm	1300mm
1000mm	1500mm	1900mm	1300mm
1000mm	2000mm	2400mm	1300mm
1200mm	1500mm	1900mm	1500mm
1200mm	2000mm	2400mm	1500mm
1200mm	2500mm	2900mm	1500mm
1200mm	3000mm	3400mm	1500mm
1500mm	1500mm	1900mm	1800mm
1500mm	2000mm	2400mm	1800mm
1500mm	2500mm	2900mm	1800mm
1500mm	3000mm	3400mm	1800mm

4.2. Mini Maxi Single Package Contents

This section highlights the various components that come with the Mini and Maxi Single package pump station as standard and optional extras if ordered.

Pump System Components	Image
<ul style="list-style-type: none"> 1 X MDPE Chamber 1 X Pump 1 X Internal Pipework 1 X Guiderail and Chain 1 X Non-Return Valve 1 X 40mm Cable Duct 1 X 110mm Wall Seal 1 X Access Cover 	
Optional Outlet	Image
<ul style="list-style-type: none"> MDPE 63mm / 90mm Outlet Connector (depending on pump) 	
Optional High-Level Alarm	Image
<ul style="list-style-type: none"> High-Level Alarm C/W Float Switch and Cable Glands 	

5. Mini/Maxi Twin System Overview

The below is a visual representation of the DPT Mini and Maxi Twin pump station with associated components. Please take time to review the pump station prior to installation.

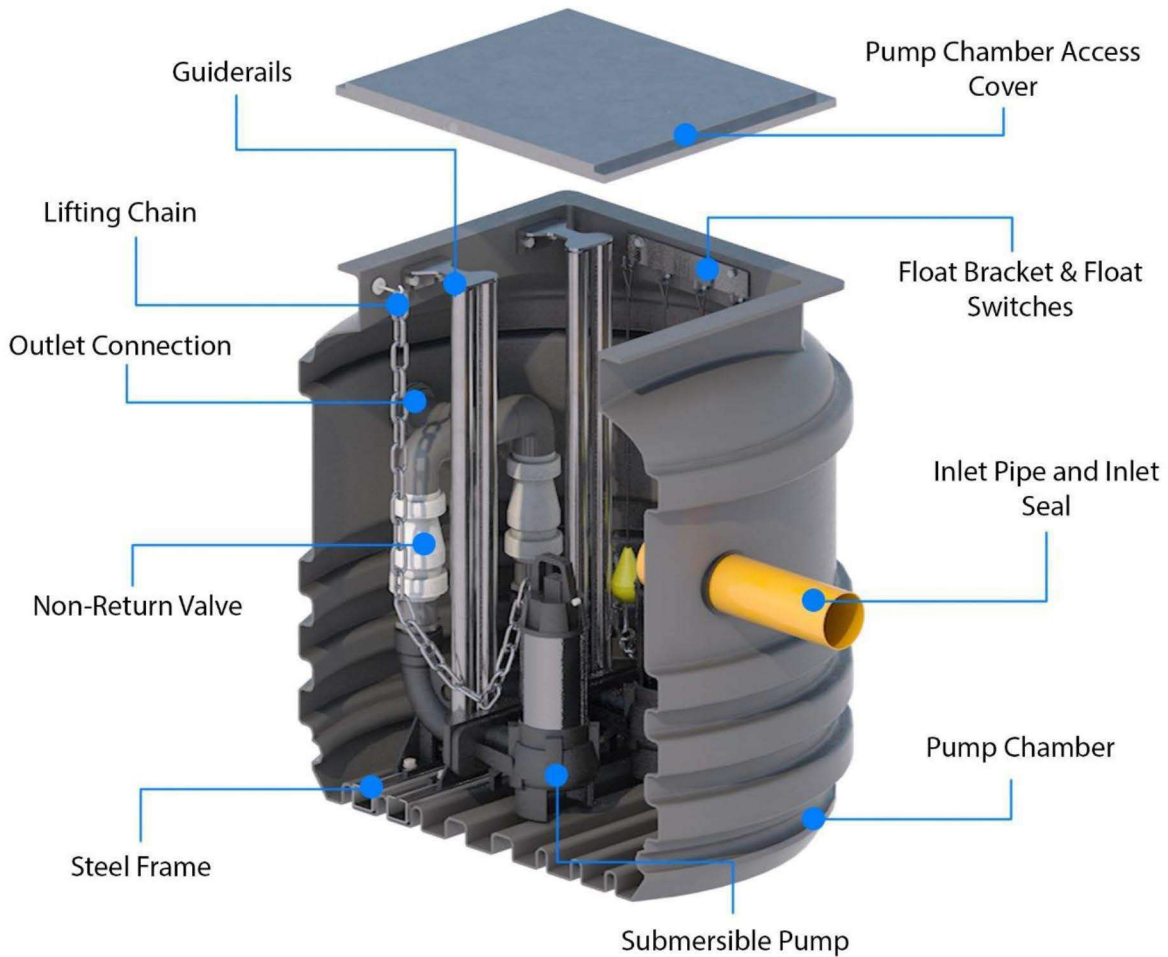



5.1. Chamber Dig Depths

Chamber Diameter	Chamber Depth	Minimum Excavation Depth	Minimum Excavation Diameter
1000mm	1000mm	1400mm	1300mm
1000mm	1500mm	1900mm	1300mm
1000mm	2000mm	2400mm	1300mm
1200mm	1500mm	1900mm	1500mm
1200mm	2000mm	2400mm	1500mm
1200mm	2500mm	2900mm	1500mm
1200mm	3000mm	3400mm	1500mm
1500mm	1500mm	1900mm	1800mm
1500mm	2000mm	2400mm	1800mm
1500mm	2500mm	2900mm	1800mm
1500mm	3000mm	3400mm	1800mm

5.2. Mini Maxi Twin Package Contents

This section highlights the various components that come with the Mini and Maxi Twin package pump station as standard and optional extras if ordered.

Pump System Components	Image
<ul style="list-style-type: none"> 1 X MDPE Chamber 2 X Pump 1 X Internal Pipework 2 X Guiderail and Chain 2 X Non-Return Valve 1 X 110mm Cable Duct 1 X 110mm Wall Seal 1 X Access Cover 	
Optional Outlet	Image
<ul style="list-style-type: none"> MDPE 63mm / 90mm Outlet Connector (Depending on pump) 	
Optional Kiosk	Image
<ul style="list-style-type: none"> Steel Kiosk for housing pump control panel and other equipment. 	

6. Application

- 6.1. The AquaTank, Micro, Mini, and Maxi range of package pump stations are designed to collect foul and surface water from single/multiple properties that house multiple people like domestic housing, commercial offices, and other light commercial applications.

7. Maintenance

- 7.1. The AquaTank, Micro, Mini, and Maxi stations are manufactured using high quality components designed to give a long trouble-free life. With any type of mechanical equipment regular preventative maintenance is required to keep the product working efficiently on a day-to-day basis.

We recommend this system is serviced yearly by specialist pump engineers. Contact us on 0115 9444474 or contact our support team on: office@dptservices.co.uk

8. Discharge Pipework

- 8.1. The AquaTank, Micro, Mini, and Maxi pump stations have been designed to accept various sizes of discharge pipework depending on the pumps used within the system. Use the table below to familiarise yourself with the pipework required for your pump station.

8.2. Pipework Table

Pump Code	Pipework Size	Pipework Type	Termination
6VX	50mm	Solvent Weld	2" BSP
10VX	50mm	Solvent Weld	2" BSP
MC	50mm	Solvent Weld	2" BSP
AquaTank / Pro	32mm	Solvent Weld	1 ¼ BSP
65VX	80mm	Solvent Weld	3" BSP
80VX	80mm	Solvent Weld	3" BSP

9. Inlet

- 9.1. The AquaTank, Micro, Mini, and Maxi stations are provided with 2 x 110mm/150mm inlet seals, this is supplied loose. A 140mm/190mm hole-saw will be needed to fit the seal (please see accessories page). The inlet seal can be drilled anywhere on the chamber where no ribs are present, but no lower than 500mm from the bottom of the chamber; this is to ensure that the pumps can operate correctly.

*Note larger invert can be supplied on request.

10. Cable Duct Pipework

10.1. The AquaTank, Micro, Mini, and Maxi have been designed to accept 40mm and 110mm standard drainage pipes. The Micro will accept 40mm while all other sizes will accept 110mm.

11. Electrical Connections

11.1. Please refer to the table below for the correct isolator needed for each pump type:-

Pump Code	Pump Configuration	Breaker Type
AquaTank DPT01	Single	10 Amp Fused Spur
AquaTank DPT01	Twin	X 2 10 Amp Fused Spur
6VX	Single	C6 Amp Fused Spur
6VX	Twin	C32 Amp Fused Spur
10VX	Single	C6 Amp Fused Spur
10VX	Twin	C32 Amp Fused Spur
MC	Single	C12 Fused Spur
MC	Twin	C32 Amp Fused Spur
65VX	Single	C16 Fused Spur
65VX	Twin	C32 Amp Fused Spur
80VX	Single	C16 Fused Spur
80VX	Twin	C32 Amp Fused Spur

12. Electrical Connection Sample Layout

12.1. AquaTank and Micro Range

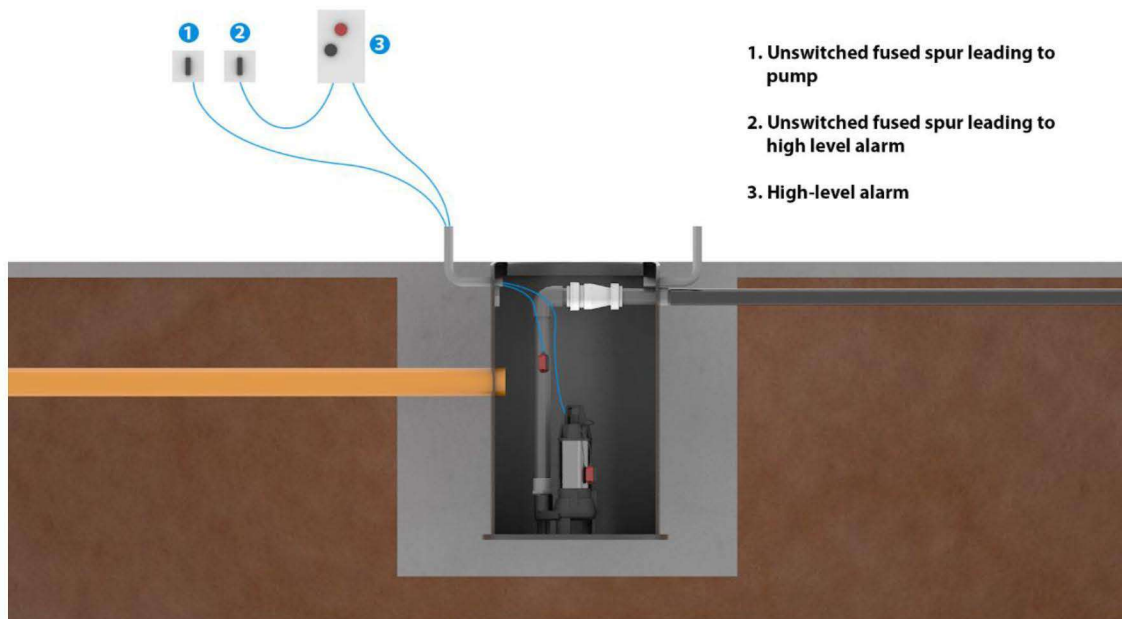

12.2. Mini Single Range

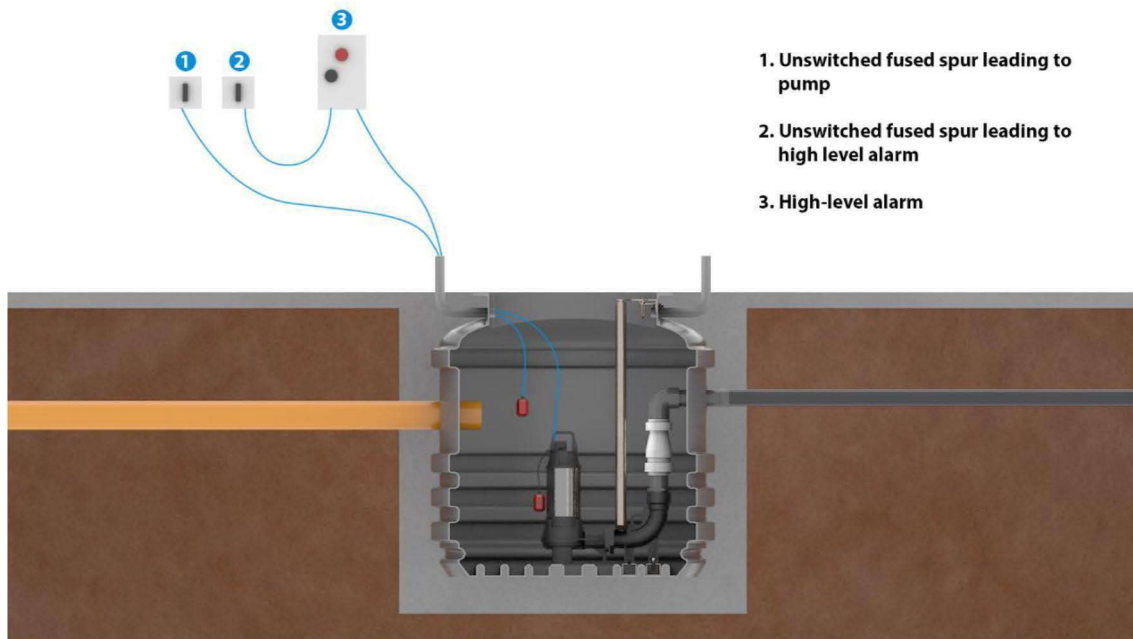

12.3. Mini Twin Range

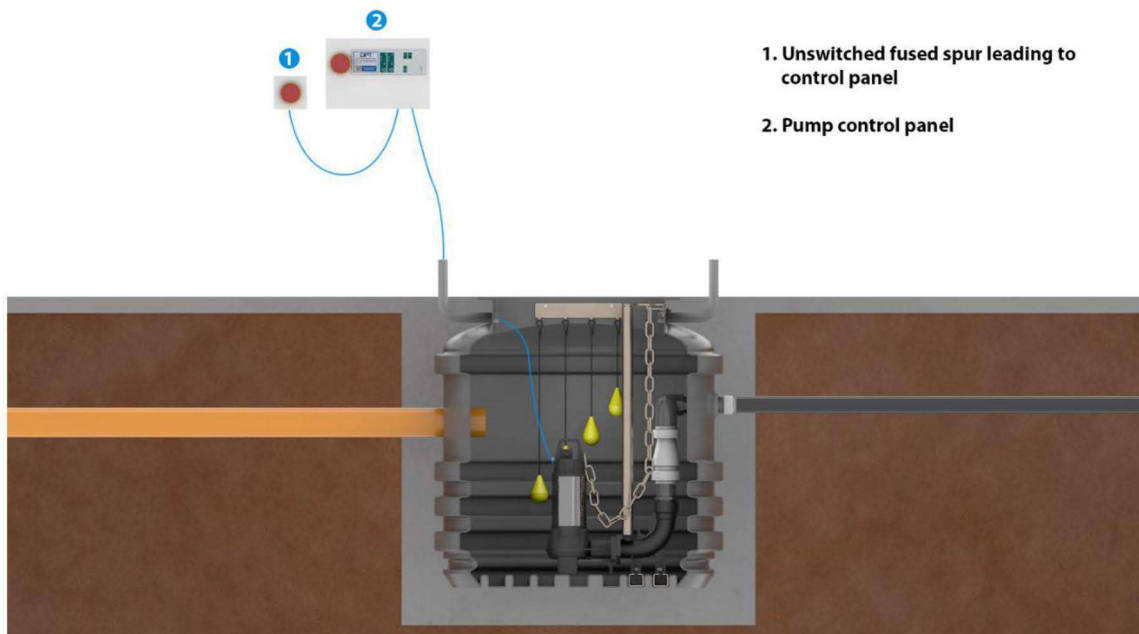

13. Installation Considerations

- 13.1. These Guidelines represent Best Practice for the installation of the above packaged pump stations (wastewater application). It must be noted, however, that these Guidelines are of a general nature. It is the responsibility of others to verify that they are appropriate for the specific ground conditions and in-service loads of each installation.

Similarly, any information or advice given by employees or agents of the company regarding the design of an installation must be verified by a **qualified** specialist (e.g. Civil engineering consultant).

14. Wet and Dry Site Descriptions

- 14.1. The DPT range of pump stations can be installed on both '**Dry sites**' and '**Wet sites**'.
- 14.2. A 'Dry site' is a site in which the water table never rises higher than the base of the tank.
- 14.3. A 'Wet site' is a site where the water table may rise higher than the base of the tank but never higher than 500mm from the base of the chamber. If the water table exceeds 500mm from the base of the tank you will need consult with a drainage expert to access the best method of installation.
- 14.4. DPT holds no responsibility for systems installed beyond these parameters, sole responsibility will lay with the installing contractor.

15. Delivery, Handling and Storage

- 15.1. Care must be taken to ensure that DPT pump stations are not damaged during delivery and handling on site. Please take care and locate the system somewhere it cannot fall and become damaged.
- 15.2. If damage, loss, or shortage is found at the point of delivery this must be reported within 48 hours of receipt along with photographic evidence.
- 15.3. The design requirements of the product will frequently mean that the centre of gravity of the unit is “offset”. Care must therefore be taken to ensure that the unit is stable when lifting and that loads are evenly distributed during lifting.
- 15.4. Lifting equipment should be selected by considering the unit weight, length and the distance of lift required on site.
- 15.5. We accept no responsibility for incorrect storage, lifting, or damage to equipment while stored on location.

16. Installation

- 16.1. Select a suitable location for the chamber. This will normally be at the lowest ground level on the site so that the facilities can drain into the chamber.
- 16.2. Check that no other structure - or special access - is required over the selected position. Provision can be made, if necessary, to place the chamber in a roadway, provided that the backfill, cover slab, and access cover are designed in accordance with the anticipated loads.
- 16.3. Check that no underground cable, pipe, or service duct lies beneath the selected position.
- 16.4. Excavate the minimum opening in the ground to receive the pump chamber and pipework to be used. This opening must allow for a minimum of 150mm of concrete around the chamber.
- 16.5. The depth of the excavation needs to be at least 400mm deeper than the overall tank depth.
- 16.6. If a machine is used to remove the soil, then the sides of the excavation should be battered for stability and a sump left should it be necessary to dewater. If it is dug by hand, the sides will need shoring up for safety, to prevent earth slippage.
- 16.7. A de-watering pump may be required to control any ground water present.

16.8. The table below shows the concrete pour thickness based on the diameter of the DPT range of tanks: -

Tank Diameter (mm)	Concrete Surround min (mm)	Concrete base Depth min (mm)
610mm	150mm	200mm
1000mm	150mm	200mm
1200mm	150mm	200mm
1500mm	150mm	200mm

16.9. Prior to laying the concrete base you will need to ensure you have laid clean hardcore to a minimum thickness of 200mm.

Tank Diameter (mm)	Hardcore Base Depth min (mm)
610mm	200mm
1000mm	200mm
1200mm	200mm
1500mm	200mm

16.10. Pour a damp concrete base to a minimum thickness of 200mm and allow to partially set (use table below for concrete grades).

16.11. Lower the pump chamber onto the damp concrete, allowing the base, feet, and/or mouldings to settle in. Ensure that the inlet and outlet pipes are correctly aligned for your application and that the tank is level, ready for backfill and ballast.

16.12. Fill the chamber with water to a depth of approximately 700mm, this is vital as it is imperative that the chamber is correctly ballasted prior to pouring the concrete backfill.

FAILURE TO DO THIS WILL RESULT IN A FAILED INSTALLATION AND POSSIBLE CHAMBER IMPLOSION.

16.13. We recommend that the unit then should be backfilled with preferably a dry concrete, or a lean mix in areas where ground conditions are wet or unstable. A semi-dry mix can be used in dry ground conditions. The minimum surround thickness for this backfill should be 150mm.

16.14. All concrete requirements are site specific and will require evaluation prior to installation.

16.15. The concrete must be evenly poured around the tank periphery and must not exceed the depth of water in the tank. The concrete should be vibrated/compacted if needed to leave no voids. Care must be taken to ensure that any pipes (or other connections) made are not damaged. Concrete will secure into position any pipes that have been connected. Use of supplied wall seals is mandatory.

- 16.16. During concrete pour, ensure that tank is vertical (by use of a spirit level across the tank's opening). Additionally, ensure that the tank is at the correct depth. Allow this concrete "Anchor" to set.

DO NOT REMOVE THE WATER FROM THE TANK THE CONCRETE MUST BE EVENLY POURED AROUND THE TANK PERIPHERY AND MUST NOT EXCEED THE DEPTH OF WATER IN THE TANK. THE WATER LEVEL SHOULD BE GRADUALLY RAISED (CONSISTENT WITH THE INCREASING LEVEL OF CONCRETE POURED) AND SHOULD REMAIN 100MM HIGHER THAN THE CONCRETE BACKFILL. LEAVE THE WATER IN THE TANK UNTIL THE CONCRETE HAS SET CURED.

- 16.17. Connect the site pipework to the inlet and outlet connections of the pump chamber.
- 16.18. In all instances the pump chamber must be filled with clean water to keep pace with the backfilling process, this is to equalize the pressures exerted onto the unit and prevent the possibility of chamber deformation or flotation during installation while concrete cures.
- 16.19. We recommend that each stage of the concrete pour should be no more than 600mm at a time, ensuring that each pour is vibrated correctly before the next pour begins, this process should be repeated until you have reached the top of the tank.
- 16.20. Once connections have been made you must finish the concrete pour to the top of the chamber.
- 16.21. (If required) construct a concrete cover slab (with access opening) of maximum 200mm thickness, ensuring that the slab is supported by consolidated backfill or utilise engineering-brick courses to the sides of the opening/manway, again these must be supported by consolidated backfill/concrete.
- 16.22. The access cover/frame would have been supplied unattached from the tank. Set frame onto brick courses or into concrete (Access covers for the Micro and AquaTank system can be attached to the tank). If using brick courses, they should be no more than 400mm to maintain accessibility.

16.23. Standard access cover install example



16.24. Brick course install example

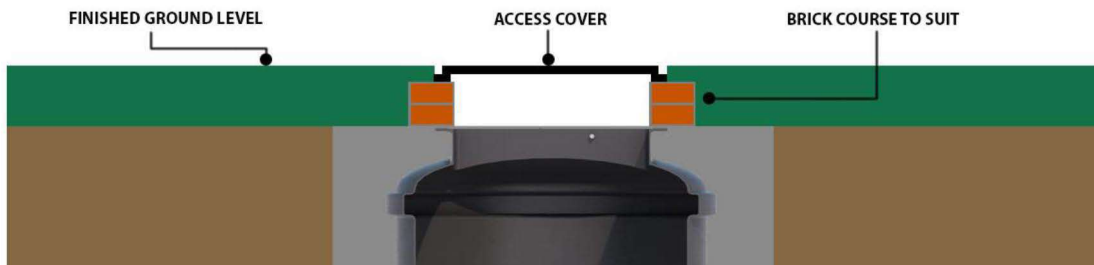

16.25. Construct concrete plinth for control panel kiosk (where applicable). This should include a 100mm diameter duct to the pump station to allow the passthrough of required cabling.

17. Example Concrete Pour and Water Ballast

- 17.1. Dig hole to correct depth as outlined in this document and lay a hardcore base and concrete slab to a minimum of 200mm each.

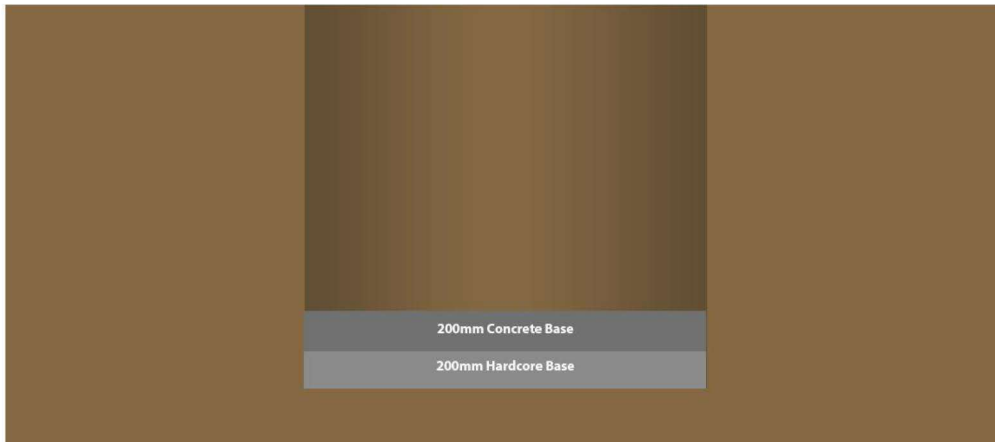

- 17.2. Place chamber in the center of the excavation and position firmly into the damp concrete base. Ensure the chamber is level and in the correct position.



- 17.3. Fill chamber with a minimum of 700mm water in readiness for the first concrete pour.



- 17.4. Lay first concrete pour ensuring the correct thickness of at least 150mm around the circumference of the chamber. Make sure that the concrete level does not exceed the level of the water.
- 17.5. Once concrete is in position, begin to vibrate the concrete to ensure that all voids are filled around the chamber.

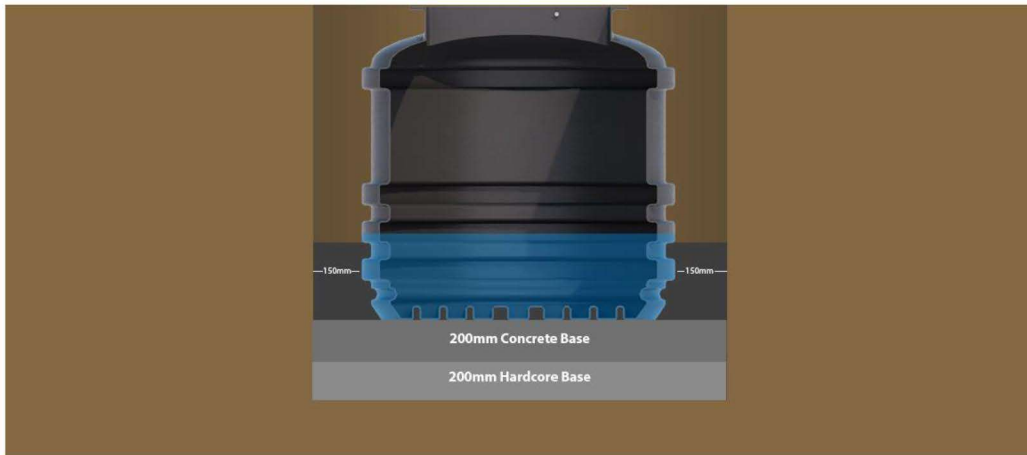

- 17.6. Repeat the process for the second pour, once again ensure that the water level exceeds that of the concrete. Ensure vibration takes place at each stage of the concrete pour.



- 17.7. Repeat the process for the third pour, once again ensure that the water level exceeds that of the concrete. Ensure vibration takes place at each stage of the concrete pour.

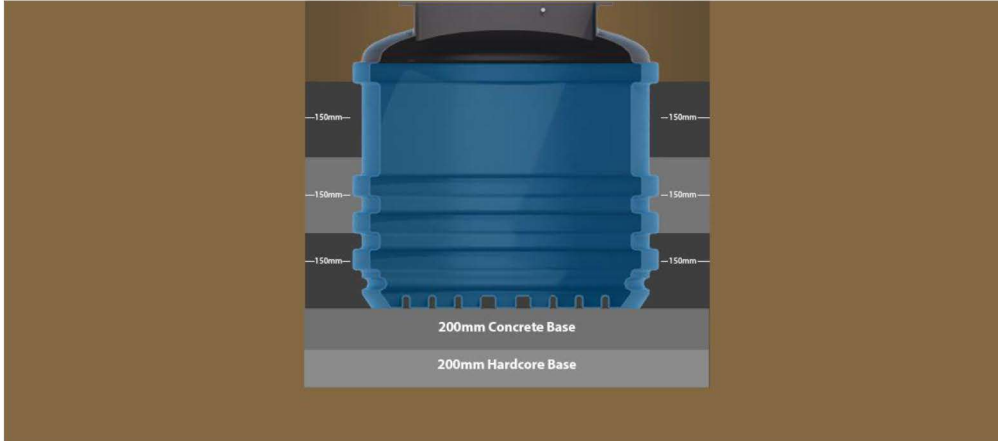

- 17.8. Complete the process by laying the final pour to the surface of the chamber, take care to vibrate the concrete.
- 17.9. Once complete you can then fix the access over in place and leave to cure.

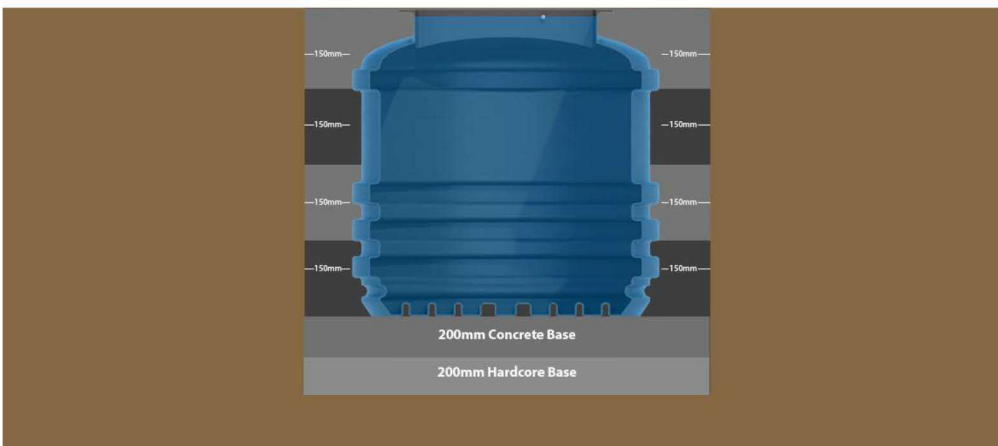

NOTE: This is a representative example of a concrete pour, you will need to take into consideration all pipework and fixings at each stage of the pour. Chamber sizes vary and it is possible you will need many more concrete pours than outlined in this example.

Although chamber sizes differ in size, capacity, and shape, the pour process remains the same for all applications.

18. Important Notes

18.1. DO NOT LEAVE ANY SUPPLIED PUMPS SUBMERGED IN WATER AS THIS WILL DAMAGE THE PUMPS AND INVALIDATE YOUR DPT WARRANTY.

18.2. Concrete Specification is not a site-specific installation design.

18.3. Concrete Table

GENERAL CONCRETE SPECIFICATION IN ACCORDANCE WITH BS EN 206-1 (BS 8500-1)		
TYPE OF MIX		(DC) DESIGN
PERMITTED TYPE OF CEMENT		BS 12 (OPC) BS 12 (RHPC) BS 4027 (SRPC)
PERMITTED TYPE OF AGGREGATE		BS 882
NOMINAL MAXIMUM SIZE OF AGGREGATE		20mm
GRADES	C25 /30 C25 /30 C16 /20	REINFORCED & ABOVE GROUND WITH HOLDING DOWN BOLTS REINFORCED (EG. FOR HIGH WATER TABLE) UNREINFORCED (NORMAL CONDITIONS)
MINIMUM CEMENT CONTENT	C30 C20	270 - 280 Kg/M3 220 - 230 Kg/M3
SUMP CLASS		S1 (25mm)
RATE OF SAMPLING		READY MIC CONCRETE SHOULD BE SUPPLIED COMPLETE WITH APPROPRIATE DELIVERY TICKET IN ACCORDANCE WITH BS EN 12350-1
NOTE: STANDARD MIXES SHOULD NOT BE USED WHERE SULPHATES OR OTHER AGGRESSIVE CHEMICALS EXIST IN GROUND WATER		

18.4. When positioning the chamber please check that your electrician has provided sufficient cable to allow the isolator switch to be placed in the required position.

18.5. It is most important that once the chamber is in position, with all the inlet connections made and before starting the pumps, the drainage system is flushed through and all sand, debris etc. is removed from the chamber.

FAILURE TO DO THIS MAY INVALIDATE THE WARRANTY ON THE SYSTEM/PRODUCT

18.6. A cable duct is required, free from sharp bends, and should be fitted on chamber 250mm from the top Ensure the cable is pulled through the duct or gland in the side of the pump chamber.

System Type	Duct Diameter
AquaTank / AquaTank Pro	40mm
Mini /Maxi	110mm

- 18.7. If DPT are to commission the system an adequate duct must be in place prior to visitation otherwise commissioning will not take place and further charges may be Incurred.
- 18.8. If the chamber is going to be subjected to traffic & or vehicle loads, it is essential that a cover slab is constructed so there is no direct load onto the chamber. Also, a suitably rated access frame and cover must be obtained and installed in such a manner that no loads bear directly onto the neck of the chamber.
- 18.9. In all instances the pump chamber must be filled with clean water to keep pace with the backfilling process, this is to equalise the pressures exerted onto the unit and prevent the possibility of chamber deformation or flotation during installation.
- 18.10. All sewer connections need to comply with local water authority regulations, DPT cannot be held responsible for any retrospective changes or applications rejected by local water authorities due to incorrect discharge rates.
- 18.11. The installer is responsible for all site work, it is their responsibility to review this document and make any required changes to the site-specific project if conditions require modification. DPT are not responsible for any changes made.

IF IN DOUBT PLEASE CONTACT US FOR ADVICE.

IT SHOULD BE NOTED THAT THIS INFORMATION IS FOR GUIDANCE PURPOSES ONLY. IT IS THE RESPONSIBILITY OF THE CONTRACTOR TO ENSURE THAT THE INSTALLATION IS CARRIED OUT TO THE SATISFACTION OF YOUR REGULATING LOCAL WATER AUTHORITY, IN ACCORDANCE WITH THE PREVAILING GROUND CONDITIONS.



Direct Pumps and Tanks Ltd
Unit 12 Cossall Industrial Estate
Ilkeston
Derbyshire
DE7 5UA
Tel: 0115 9444474
Email: info@dpondt.co.uk