

BioDisc® BA, BAX, BB, NB Installation Manual

IMPORTANT
Please read before you begin:

Once installed, the motor should be left on and running. If there is a delayed electrical connection, or if there is no power available to operate the unit, then the motor with gearbox must be removed, and stored in a dry environment. The motor must not be left non-operational for a period of 7 days or more.



Part Code	Issue	Description	Date
017900	05	ECN 1650	January 2023

Contents

	PAGE NUMBER
HEALTH & SAFETY	3
SYSTEM OVERVIEW	4
BIODISC® CHECKLIST	5
INSTALLATION	6
CONTROL PANEL	9
ELECTRICAL INFORMATION	15
WARRANTY	15
NOTICE	18

1001707

Activate your
7 YEAR WARRANTY*
for your BioDisc BA/BB today

Register online at kingspan.co.uk/klargesterguarantee

For Service and Maintenance, contact our team on:
UK: 0333 240 6868 ROI: 0818 543 500
E: helpingyou@kingspan.com



*T&Cs apply. To avail of your extended warranty you must register within 6 months of purchase.

Kingspan. | **Klargester**

HEALTH & SAFETY

Please read and follow for your own and others safety

You must read these warnings carefully before installing or using the equipment. Please ensure that you have performed a risk assessment before commencing any installation. Note that the risk assessment should be performed by a person who understands the hazards of the work, and the work environment. Note that it must be *suitable and sufficient*, i.e. adequately considers risks and ensures controls in place to mitigate risks.



You must observe all-hazard labels and take appropriate action to avoid exposure to the risks indicated. Always ensure that all relevant documents are supplied with the equipment when being transferred to a new owner.

General guidelines

- Only experienced and competent person(s) should carry out the installation.
- The unit must have a *Pre-Service Agreement Inspection* by an approved engineer.
- Take care to maintain correct posture, particularly when lifting.
- Use appropriate lifting equipment when necessary.
- A qualified electrician should carry out electrical work deemed necessary.
- The covers must be kept locked.



Personal Protective Equipment (PPE)

- We recommend the use of a dust mask and gloves when cutting GRP components.
- Person(s) carrying out maintenance on the equipment should wear suitable PPE.



Maintenance and Inspection Procedures

If you wish to inspect the equipment's operation, please observe all necessary precautions as stated in your risk assessment; including those listed below.

- The power supply must be isolated at the control panel(s) before lifting the covers.
- If the equipment should run with the covers off, care must be taken to avoid contact with moving parts and electrical components or conductors.
- Once the power has been isolated, the control panel must be kept locked shut to avoid accidental reconnection while work or inspection is being carried out.

Working Area

- Ensure that the working area is adequately lit.
- Ensure that you are familiar with the safe working areas and its access and egress.
- Use only the designated access walkways.
- Do not walk on the cover or deep well safety mesh(es).
- Always keep proper footing and your balance, avoid any sharp edges, or restricted points.

Desludging

- Desludging should be carried out by a licensed waste disposal contractor holding the relevant permits to transport and dispose of sewage sludge in your region/area.

SYSTEM OVERVIEW

Pictorial representation below indicates basic requirements for a standard system.

Cross Section

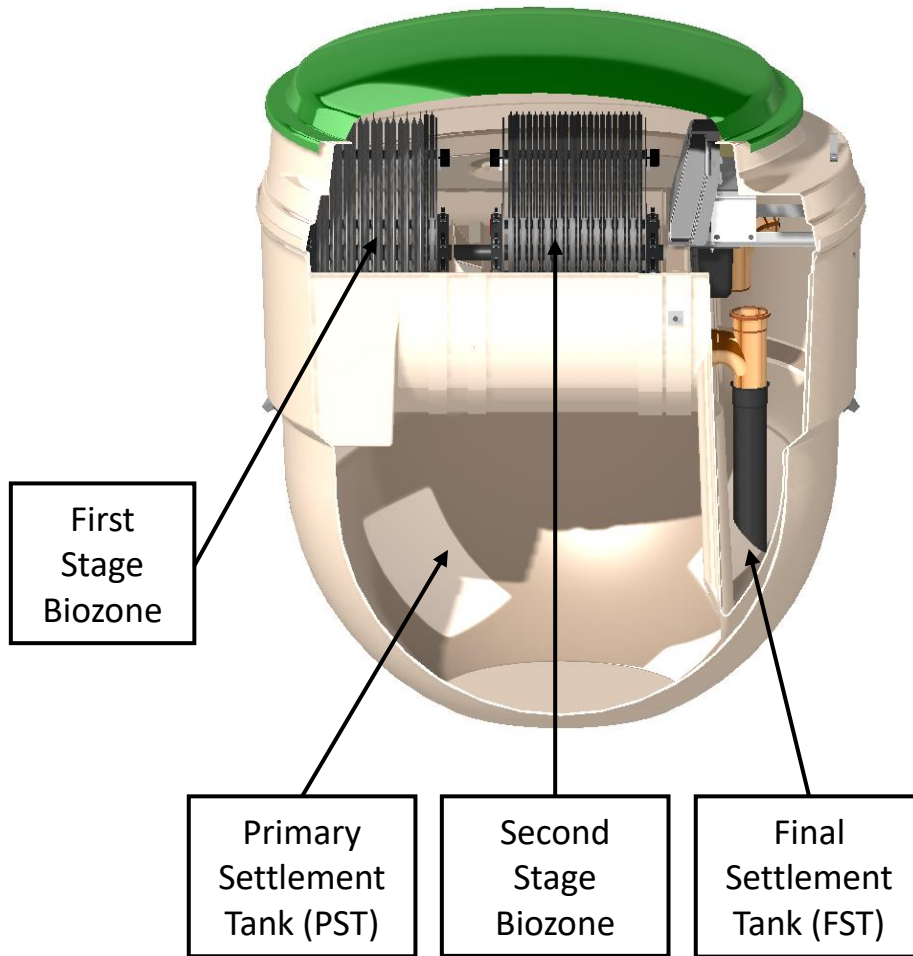

Top View

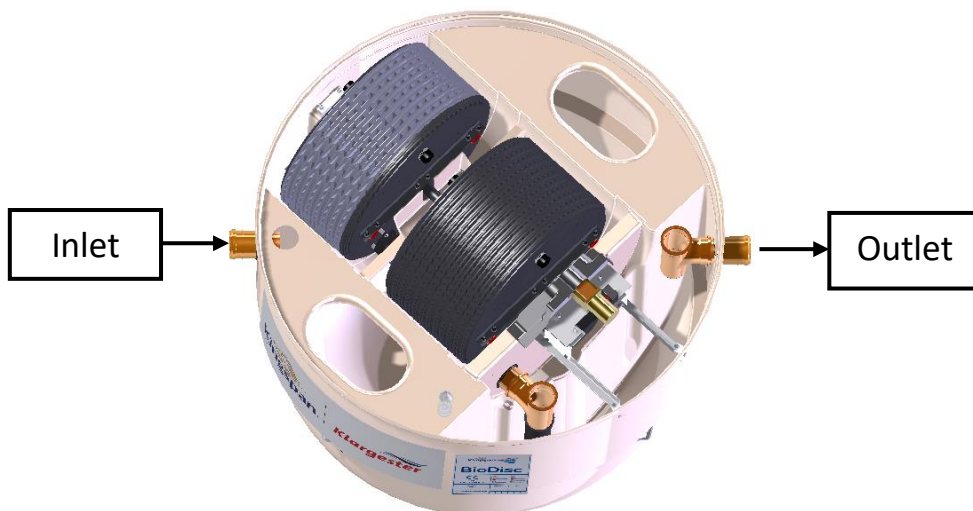

BioDisc® CHECKLIST

BA, BAx, BB & NB BioDisc

1. The unit will be fitted complete with internal pipework and equipment.
2. Inlet pipework will be fitted.
3. Unit supplied strapped to a standard pallet.
4. Unit overall heights are as follows:

INLET INVERT (MM)	HEIGHT (MM)
450	2160
750	2460
1250	2960



Holding Down Bolts

1. The holding down bolts pack will be secured to the pallet as shown in the figure to the right.
2. The holding down bolts need to be fitted to the holding down lugs that are fitted to the tank. This process is shown later in the installation section.

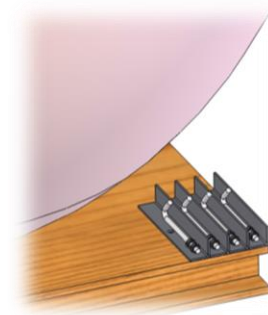

Control Panel and Beacon

1. The control panel and beacon must be removed before the tank is installed.
2. The unit control panel and beacon will be secured inside the tank:
 - The control panel is located under the motor
 - The beacon is located within the owner's pack

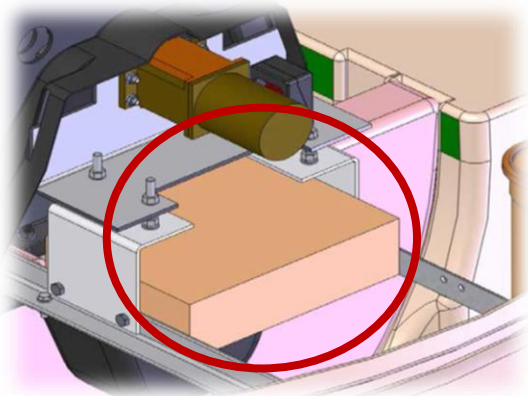

If any items are missing, Kingspan must be alerted within three days of delivery.

INSTALLATION

General

- Our domestic treatment plant are structurally tested in accordance with EN 12566-3, which specifies structural stability testing for both wet and dry sites using granular backfill 3-8mm. However, in GB it would be typical for tanks to be installed in concrete due to rising water table, and it can generally be assumed that buoyancy prevention of concrete backfill is more advantageous than the granular backfill materials used in testing.
- During installation, care must be taken to ensure the body of the unit is uniformly supported to avoid point loads on the unit.
- A water supply must be available on site to enable the unit to be ballasted during backfilling.
- When units are installed in unstable ground conditions where movement of the surrounding material and/or unit may occur, the connecting pipework must be designed to minimise the risk of damage from differential movement of the unit(s) and/or surrounding material.
- In situations where the excavation will not maintain a vertical wall, it will be necessary to support side walls of the excavation (E.g. with suitable trench sheets and bracing systems) from the bottom to the top. DO NOT completely remove the shoring system until after the backfilling is complete, but before the concrete fully hardens.
- If there is a risk of a high water table or of the site flooding, a structural design by a suitable specialist will be required to hold the tank in place.
- In areas where the water table is above the bottom of the excavation and/or the excavation is liable to flood, the excavation must be de-watered, using suitable pumping equipment, until the installation is complete. Ensure that the pump discharge does not saturate the ground in the immediate vicinity. In such conditions it may be advisable to line the excavation with polythene sheeting, to prevent cement being washed out of the concrete surround/base.
- Concrete Specification below is a *general* specification. It is not a site-specific installation design.

GENERAL CONCRETE SPECIFICATION IN ACCORDANCE WITH BS EN 206-1 (BS 8500-1)	
TYPE OF MIX	(DC) DESIGN
PERMITTED TYPE OF CEMENT	BS 12 (OPC): BS 12 (RHPC): BS 4027 (SRPC)
PERMITTED TYPE OF AGGREGATE (coarse & fine)	BS 882
NOMINAL MAXIMUM SIZE OF AGGREGATE	20 mm
GRADES:	C25 /30 REINFORCED & ABOVE GROUND WITH HOLDING DOWN BOLTS C25 /30 REINFORCED (EG. FOR HIGH WATER TABLE) C16 /20 UNREINFORCED (NORMAL CONDITIONS)
MINIMUM CEMENT CONTENT:	C30 C20 270 - 280 Kg/M3 220 - 230 Kg/M3
SLUMP CLASS	S1 (25mm)
RATE OF SAMPLING	READY MIX CONCRETE SHOULD BE SUPPLIED COMPLETE WITH APPROPRIATE DELIVERY TICKET IN ACCORDANCE WITH BS EN 12350-1
NOTE: STANDARD MIXES SHOULD NOT BE USED WHERE SULPHATES OR OTHER AGGRESSIVE CHEMICALS EXIST IN GROUND WATER	

1. Excavate Hole & Lay Concrete Bed

- Approximate dimensions of units:

Inlet Invert Depth (mm)	Diameter (mm)	Base to Ground Level (mm)	Internal Volumes of Unit (m ³)	
			Base to Outlet	Outlet to Ground Level
450	1995	1945	3.00	3.00
750	1995	2245	3.00	4.75
1250	1995	2745	3.00	7.50

- Excavate a hole with clearance on all sides and base of the unit of 150 – 200 mm, depending on site conditions.
- If shuttering is required to maintain a vertical wall, increase the width of the excavation to accommodate.
- If the excavation has an **unstable base**, excavate an additional 250 – 300 mm and fill with compacted hard-core.
- If water is present in the excavation, de-water using suitable pumping equipment. Place a sheet of polythene over the base and up the sides of the excavation before creating the concrete slab.
- The four anchor bars must be assembled and attached to the tank as shown.
- A minimum base of 150 – 200 mm of lean mix concrete is required for all ground conditions. The installer must ensure that the base is adequate to support the weight of the tank and its contents.
- It is recommended to backfill with C25 SEMI-DRY MIX.

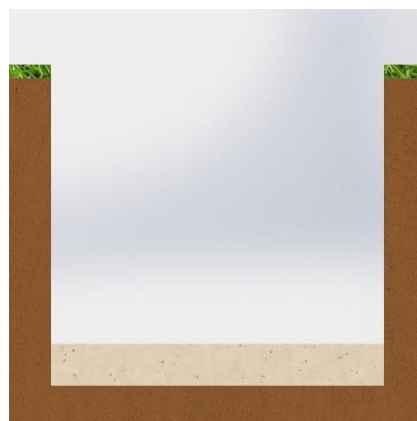

2. Lower Unit onto Concrete & Ensure Level

- Approximate weights of units in kilograms, depending on inlet invert:

Inlet Invert (mm)	BA (kg)	BAx (kg)	BB (kg)	NB (kg)
450	310	335	335	360
750	325	350	350	375
1250	380	405	405	430

- Lower the tank into the hole. A suitable spreader bar must be used with lifting slings located through the lifting points provided on the tank.
- The slings must not be attached to the inlet or the outlet pipe.
- Tank must not be lifted with any water inside.
- Check the **Inlet** and **Outlet** pipe orientation is correct.
- Check the unit is levelled. The rotor shaft must be level end to end, to within ± 3 mm, measured at the bearing caps or directly on the shaft. The unit must also be level to within ± 5 mm from side to side, measured at the GRP platform on either side of the rotor.
- Check the BioDisc rotates freely with no clashes before turning on to ensure no damage occurred during transit.



3. Backfill the Tank Unit

- The backfilling must start before the base has hardened and must be a single continuous operation, so the tank has a full concrete jacket without joins.
- The backfill must be free from organic material, large stones, brick or sharp objects.
- Backfilling must be carried out in layers, making sure that voids are not left under or around the sides of the tank and there are no localised stress concentrations.
- The installer must progressively fill the tank via a hose while keeping the water level 300 mm above the backfill to stabilise pressures on the tank. **If the pressures are not stable the tank can become distorted and damaged.**

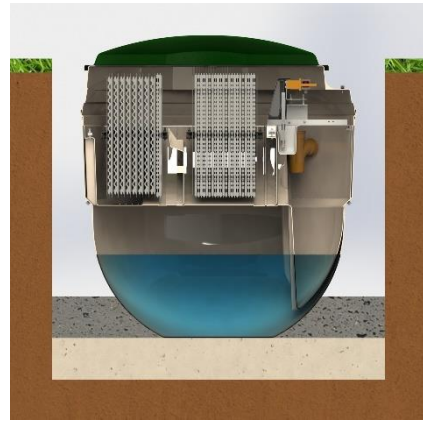

4. Second Backfill Stage

- Continue to fill the tank with water and backfill evenly around the tank, consolidating in 300 mm layers.
- DO NOT use vibrating pokers to consolidate concrete.
- DO NOT discharge concrete directly on to the tank.
- Ensure that the concrete is not too wet and that is tamped in around the tank.
- Continue until just below inlet and outlet pipework.
- Remove covers and connect inlet and outlet pipework.

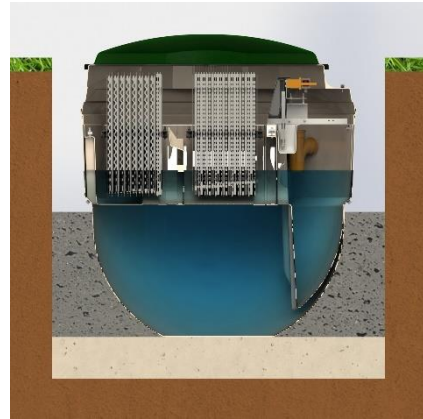

5. Final Stage

- Determine the number of cables to be connected to the control panel from within the BioDisc. A cable will be required for every occupied gland hole on the control panel, use the 'Control Panel Entry Points' table on Page 9 to determine how many gland holes will be in use.
- Drill a 15 mm hole in the BioDisc case for every cable. The holes must be located 100 mm below ground level and adjacent to one end of the baffle supporting the Motor/gearbox.
- Erect the Control Panel as described on Page 9.
- Continue to concrete backfill up to the lip of the cover.
- Once the unit has been installed, it must be left filled with water.

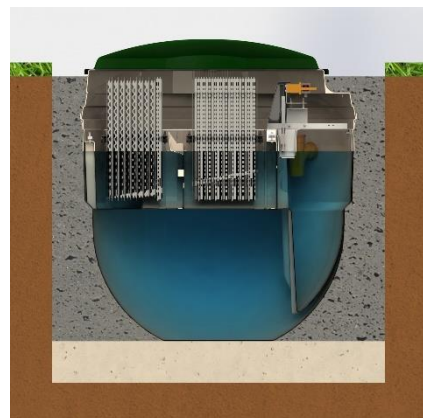

CONTROL PANEL

Refer to Manual 1011026 for details on Wiring and Setting up the panel.

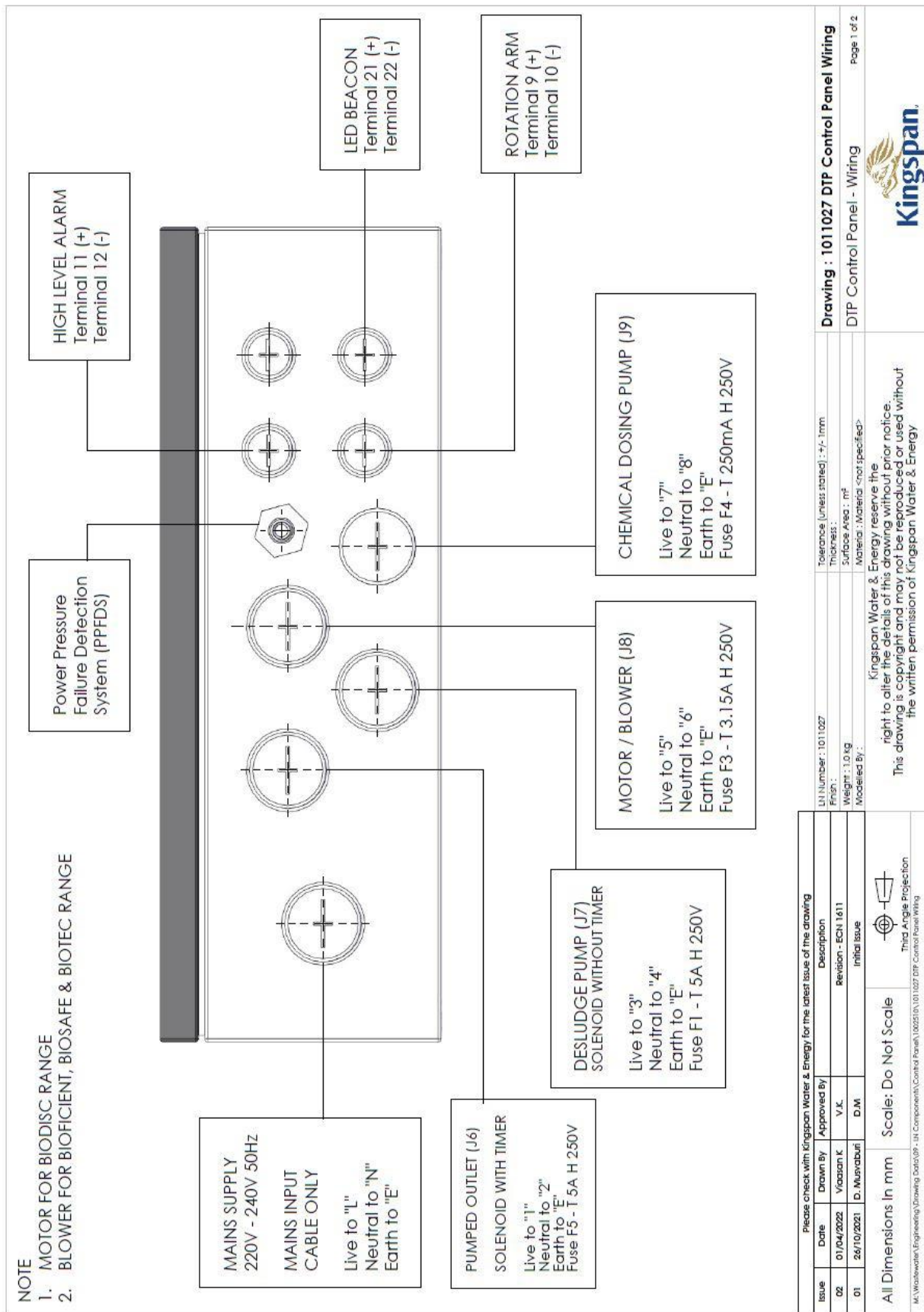

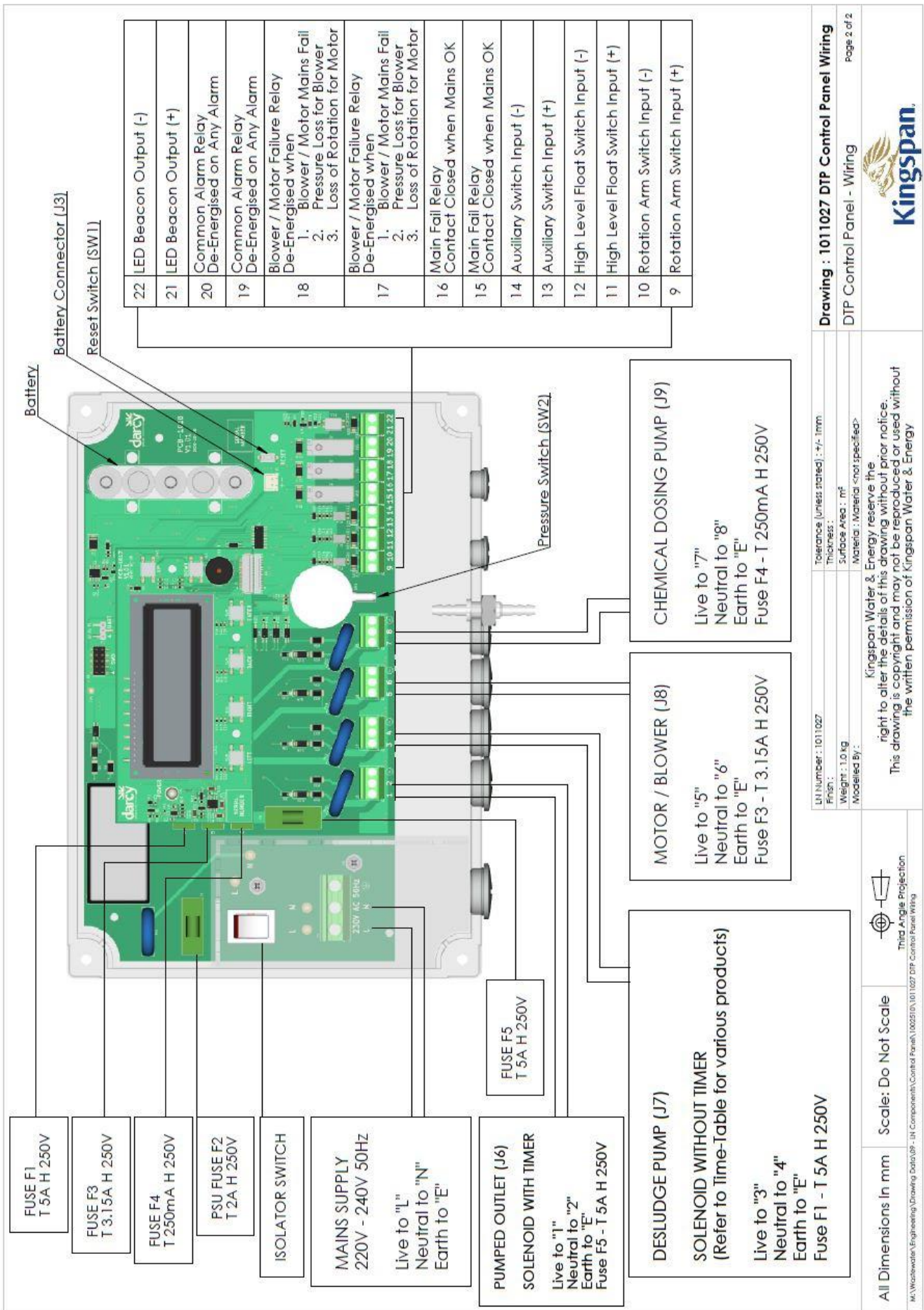

Mounting the Control Panel

- The control panel must be fitted by a qualified electrician working to the latest IEE Regulations.
- The control panel must be positioned so it cannot be reached by someone standing in or on the BioDisc unit.
- It can be wall mounted or fixed to the mounting frame (available separately).
- Allow 350mm minimum clearance from finished ground level to the bottom of the panel.
- When using a mounting frame, set the frame legs in a concrete base, minimum 250mm thick and prop the frame to prevent movement until the concrete has set.

Control Panel Entry Points

Use the diagram below to select the correct gland hole and terminations to connect all the electrical equipment to the control panel. The diagrams and instructions on the following pages give more in-depth guidance on setting up the various equipment configurations.

Mains Supply

1. Remove the four screws on the front of the panel and remove the main cover.
2. Remove the four screws holding the safety cover and remove the safety cover.
3. Remove the two screws holding the isolating cover and remove the isolating cover.
4. Using a suitable M20 gland, feed the mains power supply through Gland Hole 1. Wire the mains supply to the terminal blocks following the labels on the connections.
5. Replace the isolation cover and screws.

Motor

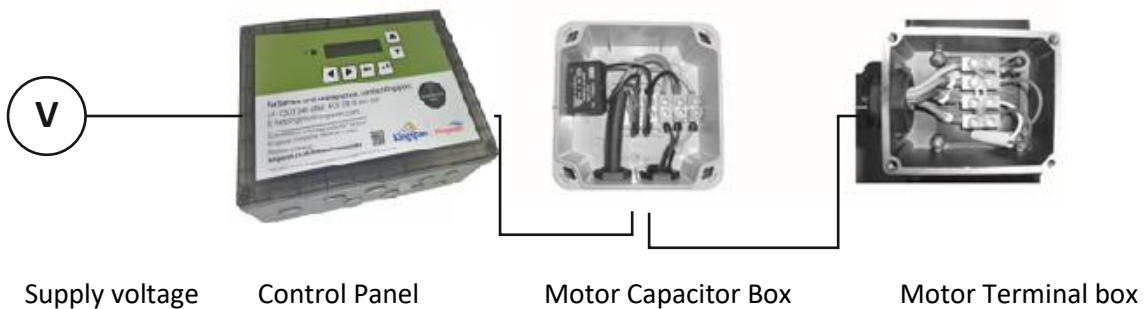

1. Before connecting the motor check the BioDisc rotates freely with no clashes to ensure no damage occurred during transit.
2. A capacitor is required for the correct function of the motor on all BA, BAx, BB and NB BioDiscs.
3. The Motor Capacitor Box will be found inside the neck of the BioDisc.
4. The Motor Terminal Box will be found on the motor.
5. Remove the four screws and the cover from the Motor Terminal Box on top of the motor.

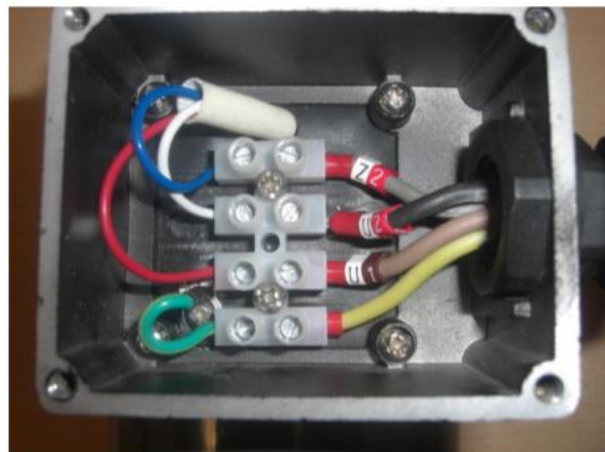

Motor Terminal Box

6. Feed the Pre-fitted Cable from the Motor Capacitor Box through a suitable M20 gland to the Motor Terminal Box and wire as shown. Grey (Z2) to blue, black (U2) to white, brown (U1) to red and Green/yellow to E.
7. Replace the cover on the Motor Terminal Box on the motor.
8. Tighten the cable gland to ensure no moisture can enter the Motor Terminal Box.
9. Remove the four screws and the cover from the Motor Capacitor Box.
10. Feed the Motor Power Supply Cable from the Control Panel to the Motor Capacitor Box. In the Motor Capacitor Box connect the mains power cable, capacitor and Pre-fitted Cable as shown. Green/yellow to green/yellow, blue to grey and blue to the capacitor, which is in turn connected to black, black to brown.
11. Feed the Motor Power Supply Cable through Gland Hole and connect to points 5 and 6 as shown on Page 9.



Pre-fitted Cable Motor Power Supply Cable

Motor Capacitor Box

Loss of Rotation Alarm

The alarm sensor (reed switch) is mounted adjacent to the motor/gearbox assembly. The sensor may be supplied out of position to allow for possible minor rotor movement during transport. Check the sensor position and ensure there is a gap of 5 - 10 mm between the sensor and the actuator magnet.

Using a suitable M12 gland, feed the loss of rotation alarm cable through Gland Hole and terminate to connections 9 and 10 as shown on Page 9. Connect the other end of the loss of rotation alarm cable to the junction box in the plant.

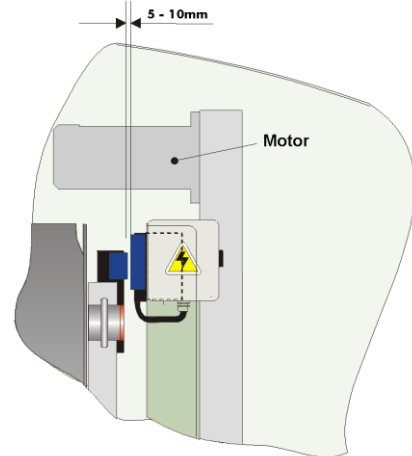

Check operation of the Loss of Rotation Alarm as follows:

1. Remove the main cover and switch off the Control Panel.
2. The display will read "Mains Failure"
3. Disconnect the cable to the motor.
4. Switch the Control Panel on. After no more than a couple of minutes the display will read "Loss of Rotation".
5. Switch the Control Panel off.
6. Reconnect the cable to the motor and replace the safety cover.
7. Switch the control panel on. The display will request to set Date & Time.
8. After resetting the Date & Time, display will return to normal running mode.
9. Replace the main cover on the control panel.

Beacon

The beacon is intended to be mounted on a wall or other solid surface. A 1.5 m cable is supplied but it can be extended up to 30 m. Using a suitable M12 gland, feed the cable from the beacon through Gland Hole and terminate to connections 21 & 22 as shown on Page 9.

Completing the Installation

1. Plug the battery lead into the small white socket of the Control Panel.
2. The display will read "Mains Failure" as there is no mains power.
3. The panel is running on battery power.
4. Replace the safety cover and turn on the mains supply.
5. Turn on the panel using the isolation switch. It should now be illuminated red. The display should now read "J7"
6. Replace the main cover on the control panel.

Fault Codes and Fuses

Please refer to Manual 1011026 for all fault codes and setting up the panel.

Pumped Outlet

Using a suitable M20 gland, feed the integral discharge pump power cable through Gland Hole and terminate to connections 1 and 2 as shown on Page **Error! Bookmark not defined.**

Check the pump, float and associated pipework are positioned as shown. With the pump chamber empty of water, the float must hang clear of the chamber floor. The correct float position and distance is essential. The float must not be able to get trapped or tangle, as this will prevent its correct operation.



High Level Alarm

Remove the link in the terminal blocks between connections 11 and 12 before inserting cables. Using a suitable M12 gland, feed the high level alarm float cable through Gland Hole and terminate to connection 11 and 12 as shown on Page 10.

Fix the bracket attached to the float to the steelwork supporting the motor using the two free holes. The base of the float must be approximately 300 mm from the bracket when held horizontally. This should align the pivot weight with the top of the final settlement tank.

Ensure the float cable will not be able to get trapped or tangled, as this will prevent its correct operation.

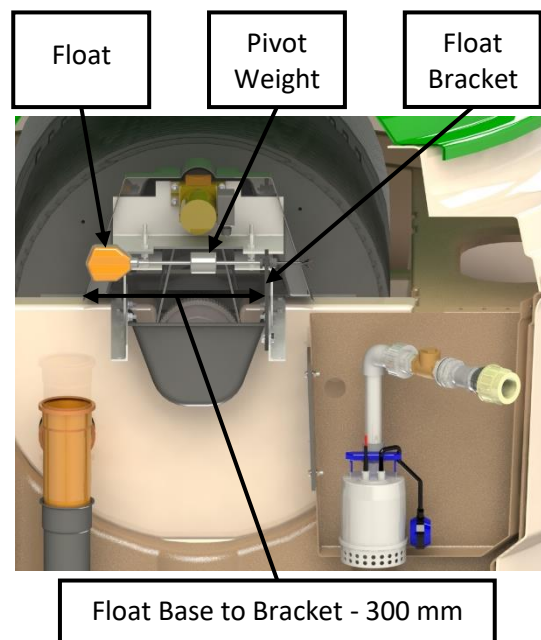

Sludge Recirculation

Please read the instructions in the standard gravity unit section for guidance on connecting the mains power supply, motor, loss of rotation alarm and the beacon.

Sludge Recirculation Pump

Using a suitable M20 gland, feed the integral discharge pump power cable through Gland Hole 3 and terminate to connection 3 and 4 (TB2) as shown on Page 14.

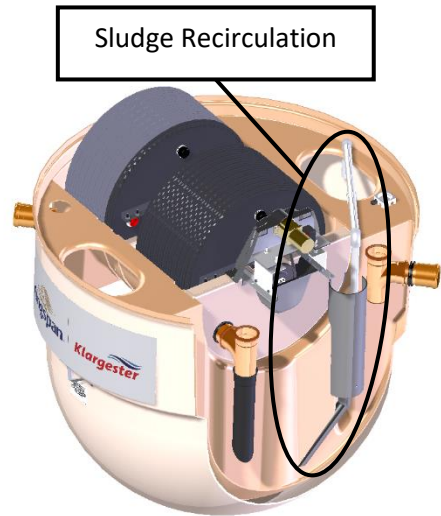

Run and Pause Time Setting

To set the desired run and pause time settings of the Chemical Dosing Pump and the Sludge Return Pump refer to Manual 1011026

Fault Codes and Fuses

To determine the meaning of the fault codes on the control unit use the table below. The related fuse location and fuse ampere rating are also shown if applicable.

All fuses are Time Lag HBC 20mm type

Low battery	Pumped outlet fuse
Loss of rotation	De-sludge pump fuse
High level float probe	Motor/blower fuse
Auxiliary input	Chemical dosing pump fuse
Blower pressure	Service due

Chemical Dosing

Please read the instructions in the standard gravity unit section for guidance on connecting the mains power supply, motor, loss of rotation alarm and the beacon.

Chemical must be supplied by others. The recommended chemical is PAX XL 60, other chemicals may be used but they must be checked for suitability. Please contact Kingspan to do so.

Chemical Dosing Pump

Using a suitable M20 gland, feed the chemical dosing pump power cable through Gland Hole 5 and terminate to connections 7 and 8 (J9) as shown on Page 14.

Connect the other end of the chemical dosing pump power supply cable to the junction box in the plant (marked CHEMICAL DOSING).

Run and Pause Time Setting

To set the desired run and pause time settings of the Chemical Dosing Pump and the Sludge Return Pump refer to Manual 1011026

Electrical Information

	Power (W)	Voltage (V)	Phase	Full Load Current (Amps)
Motor	50	230	Single	0.52
Integral Discharge Pump	250	230	Single	2.2
Sludge Return Pump	250	230	Single	2.2

Technical Specification

Technical Specification	Model	BA	BAX	BB
Parameters	PE	8	12	16
Max. Daily Flow	m ³	1.2	1.8	2.4
Max. Daily BOD5	g BOD5	360	540	720
Max. Daily Ammonia	g NH4	48	72	96
Overall Diameter	mm	1995	1995	1995
Length	mm	N/A	N/A	N/A
Inlet Invert Depth	mm	450/750/1250	450/750/1250	450/750/1250
Depth Below Inlet Invert	mm	1400	1400	1400
Outlet Invert Depth	mm	1315	1315	1315
Overall Height	mm	2160/2460/2960	2160/2460/2960	2160/2460/2960
Height to Rim of Cover	mm	1945/2245/2745	1945/2245/2745	1945/2245/2745
Empty Weight	kg	310/325/380	335/350/405	335/350/405
Standard Power Supply		1 Phase	1 Phase	1 Phase
Motor Rating - Single Phase	W	50	50	50
Full Load Current - Single Phase	A	0	0	0
Optional Power Supply		N/A	N/A	N/A
Motor Rating - Three Phase	W	N/A	N/A	N/A
Full Load Current - Three Phase	A	N/A	N/A	N/A
Sludge Return Pump Rating	W	250	250	250

WARRANTY

The company will replace or, at its option, properly repair without charge any goods which are found to be defective and which cause failure in normal circumstances of use **within a period of twelve months from the date of delivery.**

This warranty is conditional upon:

- (a) The Buyer notifying the Company of any claim within Seven days of the failure becoming discernible.
- (b) The Company being allowed a reasonable opportunity to inspect the goods so as to confirm that they are defective.
- (c) The goods not having been modified, mishandled or misused and being used strictly in accordance with any relevant instructions issued by the Company.

The Company's liability under this Clause is limited to the repair or replacement of the defective goods, and does not cover costs of transport, installation or associated site costs, if applicable.

The Company's liability to replace or repair the goods is in lieu of and excludes all other warranties and conditions, and in particular (but without limitation) the Company shall have no liability of any kind for consequential loss or damage.

A warranty form is included in this package, to register your unit for warranty. Please complete ALL sections of the form and return it at your earliest convenience.

Also within this manual is a **Notice**, describing the necessary maintenance for the plant. This should be fixed within the building.

For any further advice, please contact our Service & Warranty department on +44 (0) 844 225 2785. It would be helpful if you provide your equipment serial number.



Extended warranty for your **Klargester** BioDisc domestic treatment plant explained

Enjoy a seven year extended warranty period for your BA, BB or BAX Klargester BioDisc sewage treatment plant. In this document, we have outlined the benefits and terms associated with your extended warranty period.

For further enquiries, please contact our Kingspan Service team on:

 helpingyou@kingspan.com

 0333 240 6868
(NI 028 3836 4600 | ROI 0818 543 500)

 kingspanservice.com

How to activate your extended warranty





Register your domestic BioDisc treatment plant online at:

www.kingspan.co.uk/biodisc-guarantee

Benefits of your extended warranty



Upon activating your extended warranty for your BioDisc treatment plant, you will benefit from:

-  Replacement parts if required for your BioDisc system (fair wear and tear only).
-  Free expert technical support from our Kingspan Service team.
-  Remain fully compliant with local DEFRA/Environment Agency regulations.
-  Peace of mind with no disruption or downtime needed for maintenance or repairs.

Terms of your extended warranty

To ensure your extended warranty is valid, please adhere to the following terms:

- To activate your extended warranty, you must register online at kingspan.co.uk/biodisc-guarantee
- Your domestic BioDisc plant must be commissioned by a suitably qualified professional, either a Kingspan Service engineer or Kingspan Klargester accredited installer.
- You must arrange to have a full service of your domestic BioDisc plant within one year of registering your warranty. Contact our Kingspan Service team on helpingyou@kingspan.com to arrange a suitable date.
- Your domestic BioDisc treatment plant must be serviced once a year by a suitably qualified professional, either a Kingspan Service engineer or Kingspan Klargester accredited installer.
- When claiming Warranty, you must keep a record of all service and maintenance records carried out to your BioDisc treatment plant (either by Kingspan Service and/or the Installer).
- Any repair work carried out under the terms of the extended warranty contract will be guaranteed for a period of 28 days unless the original repair works were necessitated by reason of abuse or misuse of the system (in which case any all repair works will be chargeable).
- The extended warranty will be invalidated if you do not give us a reasonable opportunity to inspect the goods and the system to confirm the cause of the problem which you have encountered with it.
- The warranty will be invalidated if you abuse and/or Misuse the goods and/or the system.
- The warranty set out above will be invalidated if you use the goods and/or the system in any way which is inconsistent with any of the following:
 - (a) any specific instruction given to you by us;
 - (b) the manufacturer's guidelines; or
 - (c) any operating instructions.
- The warranty set out above will be invalidated if you fail to notify us in writing of the defect or failure in the goods or system within 14 days of your discovery of the defect or failure.
- We cannot take responsibility for any loss of profit, which you may suffer as a result of any failure or defect in the goods or system.

NOTICE



BioDisc

The foul drainage from this property discharges into a package treatment works.

Maintenance is required, the frequency of which depends upon the model installed, its use and application. Please consult your Operation & Maintenance Manual.

- * A BA BioDisc requires annual maintenance and desludging.
- * A BAx BioDisc requires annual maintenance and desludging at 9 month intervals.
- * A BB/NB BioDisc requires annual maintenance and desludging at 6 month intervals.

Refer to owner's manual for information on desludging points.

Maintenance and Desludging should be carried out by the owner in accordance with the Manufactures instructions.

THE OWNER OF THE PROPERTY IS LEGALLY RESPONSIBLE FOR ENSURING THAT THE SYSTEM DOES NOT CAUSE POLLUTION, A HEALTH HAZARD OR A NUISANCE.

We recommend that a separate log is kept of all maintenance and service visits, the log should detail the date and any action taken, e.g. Regular maintenance service, breakdown visit, desludge volume removed, parts replaced.

This notice should be fixed by the owner within the building alerting current and future owners to the maintenance requirement.

(Building regulation H2 (1.57))

Please contact Service NI on 028 383 64600 or Service Department Ireland on 0818 543 500 to arrange a maintenance service or to request replacement operating instructions. It would be helpful if you provide your equipment serial number.



Declaration of Performance

According to the harmonised technical specification EN:12566-3+A2:2013

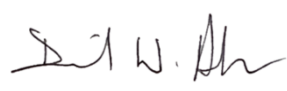
Identification code	Waste Water Treatment Plant For Up To 50 Population Equivalents. BA, BB, BC, BD & BE BioDisc.
Type	BioDisc Prefabricated Domestic Waste Water Treatment Plant: BA to BE.
Use	Collection & Treatment of Waste Water from Domestic applications up to 50 Population Equivalent.
Manufacturer	Kingspan Water & Energy Ltd, College Rd North, Aston Clinton, Aylesbury, Buckinghamshire, HP22 5EW.
Attestation of system conformity	PIA Prüfinstitut für Abwassertechnik GmbH, Notified Body No: 1739 Has executed initial type testing according to system 3 and delivered the test reports.
Essential Characteristics	Performance
Structural Behaviour	Confirmed by Pit Test under the following Conditions: - Maximum installation Depth 0m over cover level - Wet conditions maximum water level 2.49m
Resistance to fire	Class E
Water Tightness (water test)	Pass
Material Durability	Creep Factor $\alpha_{\text{material}} = 0,48$ (average value)
	Ageing Factor (β) = 0,46 (average value)
Emission of Dangerous Substances	NPD
Signed for and on behalf of the manufacturer. Portadown 22 September 2021	 David Anderson – Water Business Unit Director

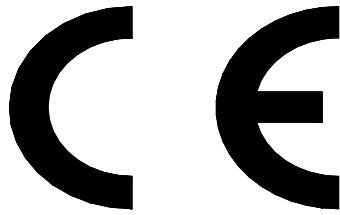

EN 12566-3+A2:2013

Name of Product Type		BioDisc	
Treatment process		Rotating Biological Contactor (RBC)	
Nominal organic daily load		0.29 kg BOD₅/day	
Nominal hydraulic daily load		1.2 m³/day	
Testing authority		PIA GmbH, NB 1739	
Treatment Efficiency	COD	89.4%	59 mg/l
	BOD₅	95.7%	10 mg/l
	NH₄-N	88.6%	3.8 mg/l
	SS	94.8%	15 mg/l
	P	NPD	NPD
	KN	NPD	NPD
Power consumption		1.3 kWh/d	

Contact Details

UK

Kingspan Water & Energy Ltd.
College Road
North Aston
Clinton |
Aylesbury
Buckinghamshire | HP22 5EW

T: +44 (0) 1296 633 000
F: +44 (0) 1296 633 001
E: klargest@kingspan.com

www.kingspan.co.uk/klargest

Ireland

Kingspan Water & Energy
Ltd.Unit1a | Derryboy
Road Carnbane Business
Park
Newry | BT35 6QH

T: NI: +44 (0)28 3026 6799
F: ROI: 0818 544 500
E: klargestinfo@kingspan.com

www.kingspan.ie/klargest

Kingspan Water & Energy Ltd.
Service Office
Details:180
Gilford Road
Portadown |
BT63 5LF

T: NI: +44 (0)28 3836 4600
F: ROI: 0818 543 500
E: helpingyou@kingspan.com

www.kingspanservice.ie