

AQUABOOST

SP3V-10HM06S-VARiFLO-24

The Aquaboost SP3V-10HM06S-VARiFLO-24 booster set utilises WRAS approved components* and features three stainless steel multistage pumps mounted on a galvanised steel base plate. The pumps are operated by our advanced variable speed controller and will deliver a nominal flow rate of 10 m³/h (Per Pump) and nominal head pressure of up to 5.4 bar.

*WRAS & KIWA Regulation 4 approval pending



Features

- Flow rates up to 14 m³/h (per pump)
- Head pressure up to 5.4 Bar
- Variable speed pump control
- Duty-assist-standby and duty-assist-assist modes
- Full WRAS & KIWA Regulation 4 approval pending
- 304 Stainless Steel pumps
- 304/316 Stainless steel manifold assembly
- 24 litre pressure vessel with flow through isolation & drain valve
- Air cooled inverters
- BMS Volt free contacts
- External Low Water
- Electronic dry run protection
- AV mounts & Flexible connectors optional

Applications

- Cold water pressure and flow boosting in a range of domestic, commercial and industrial applications

Product Code Structure

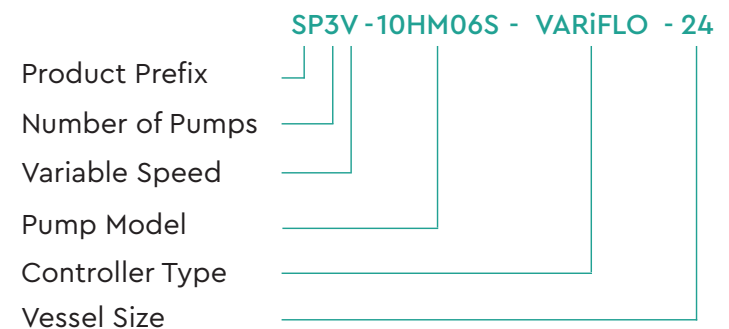

Pump Characteristic SP3V-10HM06S-VARiFLO-24

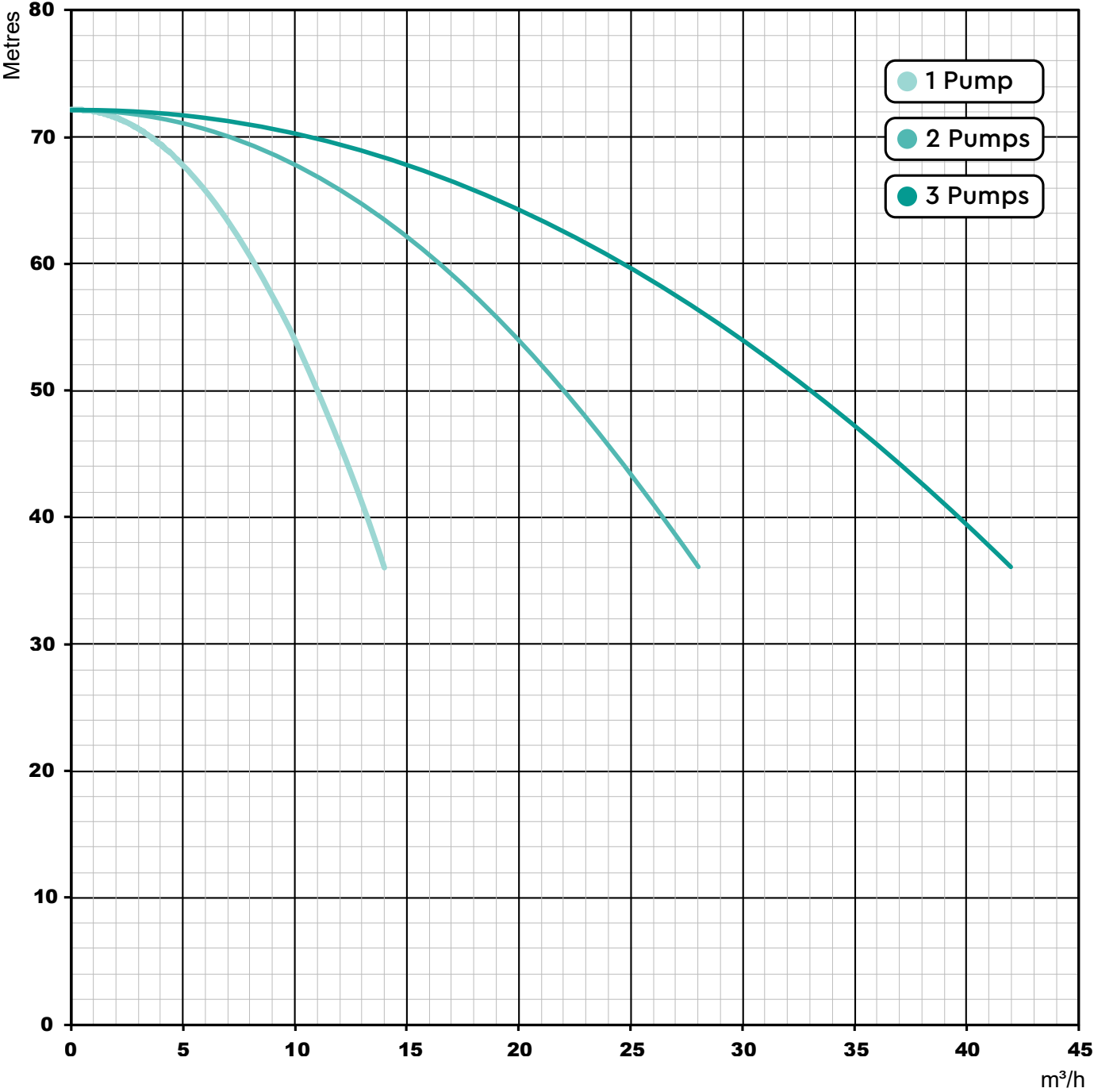

Aquaboost Model		SP3V-10HM06S-VARiFLO-24 62047
General	Warranty	2 Years
	WRAS approval	Pending
	Conformity certification	CE / UKCA
Features	Dry run protection	✓
	Glycerine filled pressure gauge	✓
	Pump check valve(s)	✓
	BMS volt-free contacts	✓
Performance	Nominal head	5.4 bar
	Maximum head (closed valve)	7.2 bar
	Nominal flow rate	10 m ³ /h (per pump)
	Maximum flow rate	14 m ³ /h (per pump)
	Minimum static inlet pressure	1 metre
	Maximum static inlet pressure	10 metres
	Maximum ambient air temperature	Max 40 °C
	Water temperature range	Min 4 °C / Max 23 °C
	Maximum working pressure (kPa / bar)	1000 kPa / 10 bar
Connections	Inlet	3" BSP
	Outlet	2 1/2" BSP
Manifold	Manifold construction	Stainless steel
	Pump isolation valves	Full bore, lever
Pump	Number of pumps	3
	Pump type	Multistage centrifugal (horizontal)
	Pump body	Stainless steel
	Impeller	Stainless steel
	Mechanical seal	EPDM / Silicon Carbide / Carbon
	Motor type	Induction (current overload sensor)
	Duty rating	Continuous (S1)
Electrical	Power supply / phase / frequency	230 V / 1 / 50Hz
	Power consumption	2.2 kW (per pump)
	Current - full load	8.6 Amps (per pump)
Physical	Enclosure protection	IP55
	Width	900 mm
	Depth	860 mm
	Height	1085 mm
	Weight	121 kg

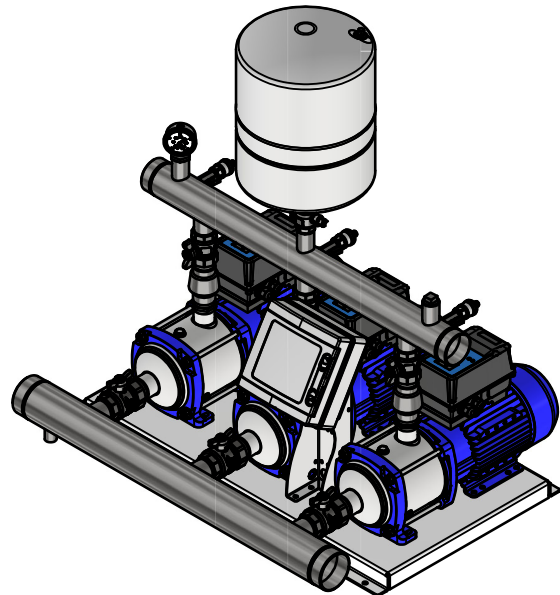
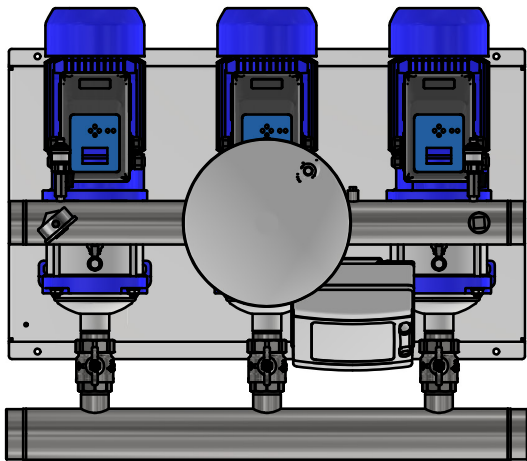
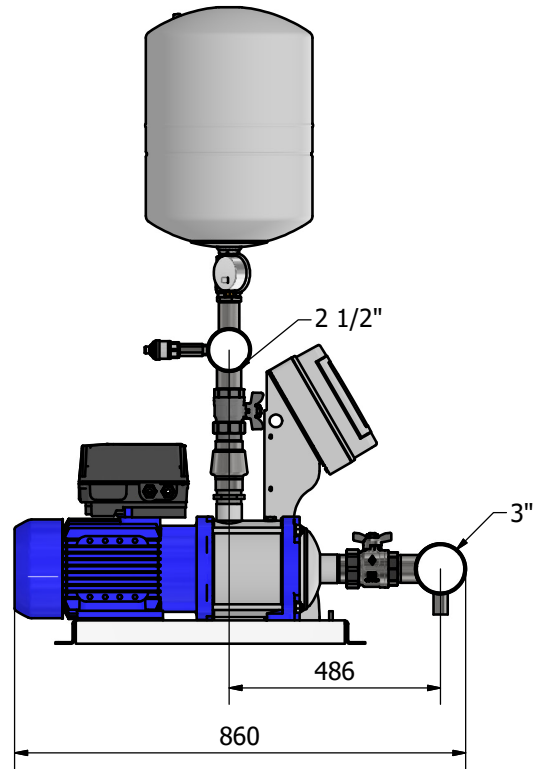
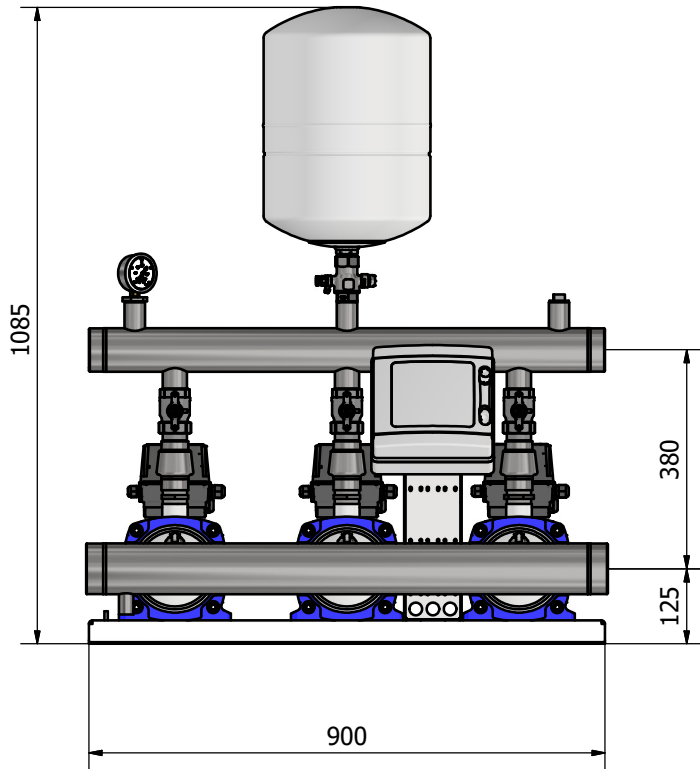

***Please add 32mm to the total height from the base of the pump when AV mounts are used.**

Stuart Turner Limited reserves the right to amend specifications without notice.

Stuart Turner Ltd, Henley-on-Thames, Oxfordshire RG9 2AD Tel: +44 (0) 1491 572655 Fax: +44 (0) 1491 573704

TechAssist Helpline +44 (0) 800 31 969 80

www.stuart-turner.co.uk

Model No. SP3V-10HM06S-VARIFLO-24 Issue 4222-01-02