

TITLE
CUCOMP.1500-1000

DRAWN BY J. Ellison DATE 17/06/2022

CUSTOMER CUSTOMER

NOTE:
All tanks must be fully supported on a flat level & continuous foundation providing structural support to the tank when full to maximum operating capacity. It is essential that the user refers to the conditions of installation document prior to the installation of the tank. Under no circumstances should the tank body be used to provide support to pipework and ancillary items. The tank lid is a structural part of the tank and must be in place and fitted correctly when water is contained within the tank.

ALL DIMENSIONS +/- 5mm UNLESS OTHERWISE STATED

DESCRIPTION:
CUCOMP.1500-1000.AG Airgap Combination Unit

A4

ALL DIMENSIONS IN MM - DO NOT SCALE

DATE	VERSION	NOTES
02/03/2022	A	FIRST ISSUE

TANK SPECIFICATION :

WET COMPARTMENT	1000 x 1000 x 1000mm
DRY COMPARTMENT	500 x 1000 x 1000mm
EXTERNAL DIMENSIONS	1692 x 1192 x 1123mm
NOMINAL CAPACITY	1000 Litres
INSULATION THICKNESS	25mm
MATERIAL	GRP

TANKS DIRECT

SCALE:1:25 SHEET 1 OF 2

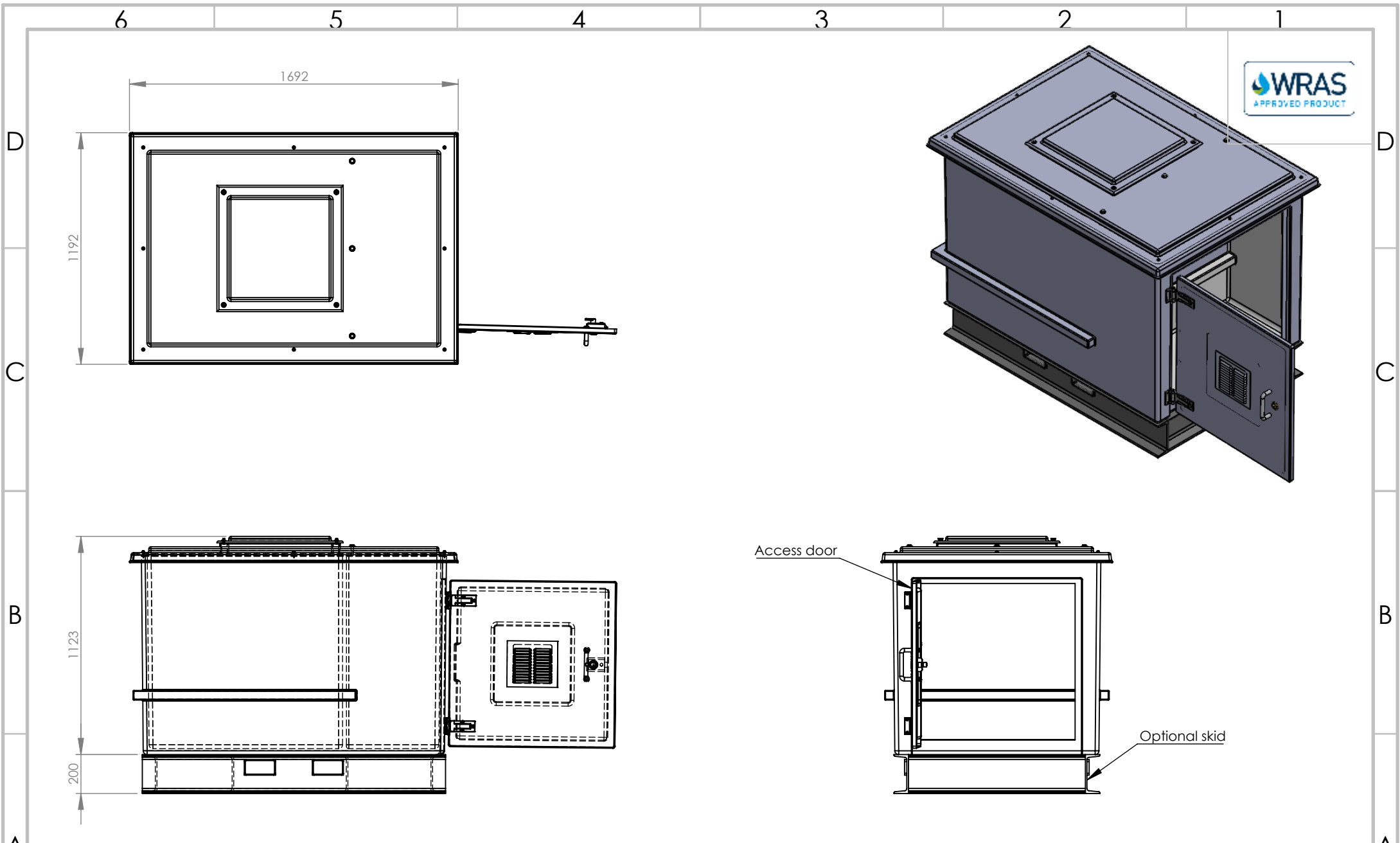

TITLE
CUCOMP.1500-1000
c/w skid

DRAWN BY J. Ellison **DATE** 17/06/2022

CUSTOMER CUSTOMER

NOTE:
 All tanks must be fully supported on a flat level & continuous foundation providing structural support to the tank when full to maximum operating capacity. It is essential that the user refers to the conditions of installation document prior to the installation of the tank. Under no circumstances should the tank body be used to provide support to pipework and ancillary items. The tank lid is a structural part of the tank and must be in place and fitted correctly when water is contained within the tank.

ALL DIMENSIONS +/- 5mm
 UNLESS OTHERWISE STATED

DESCRIPTION:
 CUCOMP.1500-1000.AG Airgap Combination Unit c/w steel skid

A4 ALL DIMENSIONS IN MM - DO NOT SCALE

DATE	VERSION	NOTES
02/03/2022	A	FIRST ISSUE

TANK SPECIFICATION :

WET COMPARTMENT	1000 x 1000 x 1000mm
DRY COMPARTMENT	500 x 1000 x 1000mm
EXTERNAL DIMENSIONS	1692 x 1192 x 1323mm
NOMINAL CAPACITY	1000 Litres
INSULATION THICKNESS	25mm
MATERIAL	GRP

SCALE:1:25 SHEET 2 OF 2