

REWATEC™

SAF Wastewater Treatment Plants

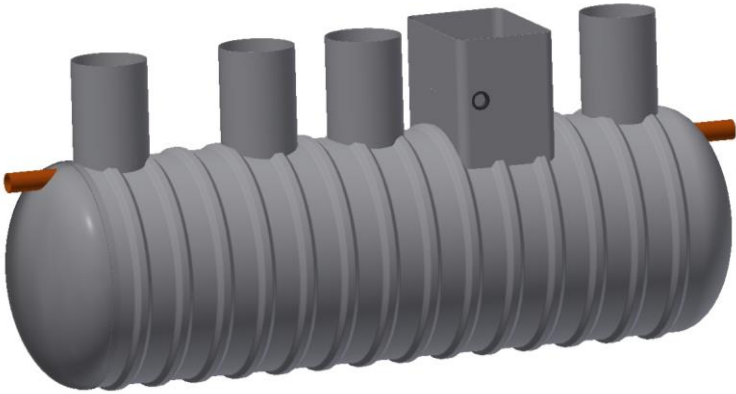

2021

Owner's Manual & Installation Guide

Rewatec Submerged Aerated Filter SAF Sewage Treatment Plant

Standard Discharge Level: 20BOD₅/30SS/20NH₃-N

SAF 30
SAF 35
SAF 40
SAF 50

Manual Version OM0008 Rev 1

Created On: April 2021



**Installers: To Safeguard Warranty Please
Ensure You Are Using The Latest
Installation Manual**

Customer Checklist

Complete Installation Record



Page 4

Register Your Warranty



Page 6

See Maintenance Schedule



Page 7-8

Familiarise Yourself With This Manual



Page 9>

Installation Record

Please record details of your SAF tank installation here and keep this document in a safe place.

Unit Installed (Please Tick)

SAF30
 SAF35
 SAF40
 SAF45
 SAF50

Serial Number:

Commissioning

Date:

Commissioning Company

Name: -----

Address: -----

Contact: -----

Service Company

Name: -----

Address: -----

Contact: -----

If you require assistance finding a service company, please contact Premier Tech. Your warranty is invalidated if you do not keep to a regular servicing schedule.



PT Water and Environment UK

+44 (0) 191 587 8650

sales.ptwe.uk@premiertech.com

PT-WaterEnvironment.co.uk



Thank you for purchasing a Premier Tech product.



To activate your warranty complete the form below to receive your warranty certificate by email:

premiertechnaqua.co.uk/forms/warranty-activation-form.aspx



Alternatively, you can send us your Warranty registration by post – see instructions at the end of this document

- Your SAF treatment plant is supplied with a 20-year parts and workmanship guarantee.
- This warranty is dependent upon the plant being installed, operated and maintained in accordance with this Installation, Operation and Maintenance manual.
- The Blower supplied with your Treatment Plant contains serviceable parts; these **MUST** be replaced, by a suitably qualified person, in line with the manufacturers operation and maintenance guide supplied.
- Proof of correct installation and plant maintenance (servicing) including purchase of serviceable parts **MUST** be retained, as these will be required in the event of any warranty claim.

Failure to comply with the above Terms and Conditions will invalidate the warranty.

Premier Tech Water & Environment Ltd accepts no liability for any damage or loss, including consequential loss, caused by the failure of any equipment supplied.

NB: The final effluent pump on the pumped discharge models is covered by a 12-month guarantee.



Rewatec SAF Maintenance Schedule

Details of servicing & maintenance requirements are located within this manual. Please use this page to record your tanks services and maintenance.

Your warranty is invalidated if you do not keep to a regular servicing schedule.

6 Month Check

Date:

Servicing Company:

Notes:

1st Annual Service

Date:

Servicing Company:

Notes:

2nd Annual Service

Date:

Servicing Company:

Notes:

3rd Annual Service

Date:

Servicing Company:

Notes:

4th Annual Service

Date:

Servicing Company:

Notes:

5th Annual Service

Date:

Servicing Company:

Notes:

6th Annual Service

Date:

Servicing Company:

Notes:

7th Annual Service

Date:

Servicing Company:

Notes:

Rewatec SAF Maintenance Schedule

8th Annual Service

Date:

Servicing Company:

Notes:

9th Annual Service

Date:

Servicing Company:

Notes:

10th Annual Service

Date:

Servicing Company:

Notes:

11th Annual Service

Date:

Servicing Company:

Notes:

12th Annual Service

Date:

Servicing Company:

Notes:

13th Annual Service

Date:

Servicing Company:

Notes:

14th Annual Service

Date:

Servicing Company:

Notes:

15th Annual Service

Date:

Servicing Company:

Notes:

Additional Resources

British Water's A Guide For Users Of Packaged Wastewater Treatment Plants can be found on the British Water website.

<https://www.britishwater.co.uk>

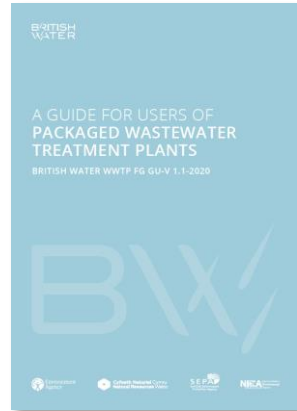

Contents

Quick Installation Guide	10
Introduction	11
Health & Safety	12
Responsibility	14
Process & Plant Description	15
Installation Instructions	19
General	19
Deep Invert Units	20
Tank Installation	20
Electrical Installation	20
Air Distribution Adjustment	21
Airlifts	22
Plant Start-Up & Shutdown Procedures	23
Start-Up & Commissioning	23
Shutdown Procedure	23
Maintenance Schedule	24
Primary Tank De-Sludging	
Humus Tank De-Sludging	
Operation Inspections	
Appendix A – Fault Finding	26
Appendix B – Equipment Specification	27
Appendix C – De-Sludging Instructions	28
Appendix D – Dimensions & Mechanical Installation	29
Appendix E – Kiosk & Electrical Drawings	33
Warranty Activation Form	41

Quick Installation Guide

Do:

- Read this O&M Manual for full details.
- Take care when offloading the unit to avoid pipework damage.
- Ensure adequate point of discharge – either into a soakaway or into a “flowing” watercourse (see section “Installation Instructions”)
- Provide a proper cable duct to the control panel or install an armoured cable. (see “Electrical Installation”)
- Isolate the main power supply to the control panel before opening it (panel isolator has to be fully in the “OFF”-position)
- Incorporate a miniature circuit breaker (MCB) in the power supply to the unit. Remember that if the MCB trips the unit will not be running, so a dedicated MCB is to be recommended.
- Ensure adequate ventilation – bugs have to breathe too!

Don't:

- Install SAF deeper than the supplied access turrets (i.e. do **not** extend the turrets)

This Operation and Maintenance Manual includes descriptive literature, specifications and drawings relating to the principal mechanical and electrical equipment incorporated in the unit. It is the responsibility of the operator to read and fully understand these instructions before installing, commissioning or operating the plant.

Introduction

Congratulations on purchasing your Conder SAF Sewage Treatment Plant. It is designed and manufactured entirely in the UK and is designed to give you long and reliable service.

This manual is supplied with your unit for the provision of installation, operating and maintenance instructions. In the unlikely event of problems occurring with your plant you may either refer to this manual, your equipment supplier or directly to Premier Tech Water & Environment.

The plant comprises three treatment stages; a primary settlement zone, an aerobic biological zone and a secondary clarification zone. The design combines the benefits of a well-proven treatment process with our engineering expertise to produce a high quality system that is robust and reliable. The plant will provide long and trouble free operation provided the simple maintenance procedures laid out in this manual are regularly carried out.

Your attention is drawn to the 'Health and Safety' section at the beginning of this manual. It is **IMPERATIVE** that you read these instructions **BEFORE** working on the plant.

The plant has been designed to treat the volume and strength of sewage specified in the original quotation. Please note the following points:

- The maximum design loading of wastewater must not be exceeded (see loading table for details).
- Surface water must not enter the plant.
- High volume discharges from swimming pools or Jacuzzi's must not enter the plant.
- Large quantities of chemicals such as water softener regenerant, disinfectants, strong acids or alkalis, oil and grease, pesticides or photographic chemicals must not enter the system.
- Do not use chemical or biological emulsifiers in grease traps.

If you have any doubt about a particular substance, please contact Premier Tech or your local supplier for further advice.

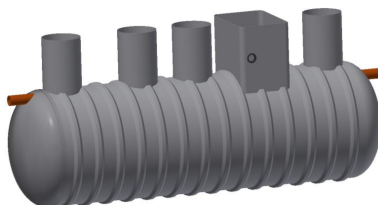

Health and Safety

(Important - Please Read This First.)

United Kingdom Health and Safety At Work Act 1974.

Section 6(a) of this Act requires manufacturers to advise their customers on the safety and the handling precautions to be observed when installing, operating, maintaining and servicing their products.

The user's attention is therefore drawn to the following:

1. The appropriate sections of this manual must be read before working on the equipment.
2. Installation and servicing must only be carried out by suitably trained or qualified personnel.
3. Normal safety precautions must be taken and appropriate procedures observed to avoid accidents

Refer to Premier Tech or your local supplier for technical advice or product information.

Health

The following is extracted from a health-warning card supplied to Premier Tech staff. It is the customer's responsibility to ensure that all necessary protective clothing/equipment is available.

Leptospirosis - what is Leptospirosis and are you at risk?

Two types of Leptospirosis infection affect people in the UK.

1. Weil's Disease - this is a serious and sometimes fatal infection that is transmitted to humans by contact with soil, water or sewage contaminated with urine from infected rats.
2. Hardjo-type Leptospirosis - this is transmitted from cattle to humans.

What are the symptoms? → Both diseases start with a flu-like illness with a persistent and severe headache, muscle pains and vomiting. Jaundice appears about the fourth day of the illness.

How might I catch it? → The bacteria can enter the body via cuts and scratches and through the lining of the mouth and throat or through the eyes.

How can I prevent it? → After having worked in contact with sewage or anything contaminated with sewage, wash your hands and forearms thoroughly with soap and

water. If your clothes, boots or tools are contaminated with sewage, wash thoroughly after handling them.

- Take **immediate** action to wash thoroughly any cut, scratch or abrasion of the skin as soon as possible. Apply antiseptic to the wound, cover with cotton wool or gauze, and protect with a waterproof plaster.
- **DO NOT** handle food, drink or smoking materials without first washing your hands.

If you contract the symptoms described above after coming into contact with sewage, report it to your doctor immediately and advise him/her of the circumstances.

Safety

Sewage gases are potentially hazardous. **DO NOT** enter the unit, any sump or primary tank.

Before carrying out any maintenance work, the equipment must be electrically isolated.

DO NOT leave manways open for any longer than is necessary. Temporary barriers and warning signs should be erected around any open covers or manways as appropriate.

Responsibility

The owner of the Sewage Treatment Plant is entirely responsible for plant operation and ensuring that the effluent quality does not breach the Discharge Consent Standards.

We can provide details of our service partners in your area who will be able to provide you with a quotation for Servicing. You are reminded that the existence of a service agreement with a service company does not transfer full responsibility for general maintenance that must be conducted in accordance with the accompanying instructions. It is still also the owner's responsibility to ensure that servicing and desludging of plant is carried out.

Soakaways, drains and emptying of Primary Tanks and Humus Tanks remain the responsibility of the owner, as does the prevention of the influx of surface water or backing up of the soakaways or treated effluent drains and as such are not covered by any service agreement. We shall not be liable for any damage or loss, including consequential loss, caused by the failure of any pumping equipment.

Process and Plant Description

The Treatment Process – Submerged Aerated Filter Technology

The unit is specifically designed to treat domestic sewage and other biodegradable waste and comprises three treatment stages (and optional final effluent pump sump):

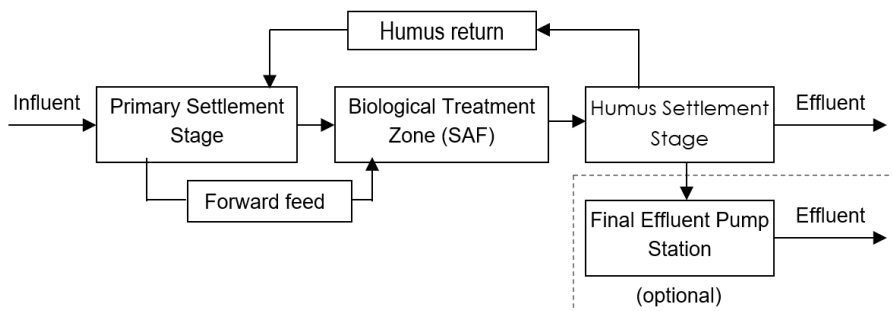

- Primary Settlement Stage
- Biological Treatment Zone
- Humus Settlement Stage (Secondary Settlement Stage)
- Final Effluent Pump Station (optional)

The system utilises micro organisms to break down the sewage by processes very similar to those that occur in a garden compost heap. It is very important therefore, that toxic chemicals do not enter the system and "poison" the micro organisms.

Raw sewage is first received in the Primary Settlement Stage, where gross solids (primary sludge) separate in the tank. These solids remain until the tank is "de-sludged" as described in the MAINTENANCE section of this manual.

The "settled" liquor is displaced from the Primary Tank and flows into the biological treatment zone. Incoming flow mixes with recycled sewage within the biozone. This recycled flow greatly dilutes the incoming sewage and prevents "shock" loads from upsetting the system.

The blower provides necessary oxygen for the micro-organisms to digest the nutrients in the bio-zone. Air is bubbled up through the bio-zone from distribution pipework and in so doing generates a recirculating flow. As the liquid moves around in the biozone it is purified by the micro organisms growing on the surface of the media. Excess biomass

solids are transferred to the humus tank or final settling tank by displacement, as new liquor enters the bio-zone from the primary tank.

The Humus solids settle to the top and bottom of the Humus tank to form a sludge. This sludge remains in the tank, until the tank is "de-sludged" as described in the MAINTENANCE section of this manual.

The fully treated liquid displaced from the humus tank is known as Final Effluent. It is suitable for discharge to a watercourse or drainage field as defined in the Consent to Discharge issued by the environmental regulator. In case the final effluent cannot "naturally gravitate" away, an optional pump can be incorporated to lift the effluent to the point of discharge.

The Treatment Plant – Conder SAF

The unit is a single tank design containing the following components required for the biological treatment of domestic sewage:

a. The Tank Structure

The glass reinforced polyester (GRP) tank is supplied complete with Pedestrian duty covers and access manways. The resin gel-coats ensure it is completely impervious to sewage, and stiffeners ensure a robust construction with a long service life. Access to the tank internals for normal maintenance is provided through two manholes in order to:

- De-sludging of Primary Settlement / Humus Settlement Stage.
- Inspection, Service and Maintenance of air distribution pipework and blower (incl. final effluent lift pump if applicable).

b. The Primary Settlement Stage

The Primary Settlement Stage forms an integral part of the tank structure. It is designed to settle out any gross solids and other insoluble materials. It contains two settlement sections, which are connected via a centre hole in the separating baffle. We recommend that this section is de-sludged every (**see table page 5**) as described in the MAINTENANCE section of this manual.

c. The Biological Zone and Distribution Assembly

The submerged aerated media is contained within this zone. The media comprises loose polyethylene tubes, to provide a very large specific surface area. Air is distributed within the media via the blower and air distribution pipework. This ensures that sufficient quantities of aerated sewage pass the biological effective surface area of the media.

d. Blower and Air Distribution Pipework Assembly

The Blower is located in a remote location from the plant and delivers air into the bio-zone.

e. Humus Settlement Stage

The Humus Settlement Stage is an integral part of the tank structure and is fed from the biozone. Humus sludge is transferred to the primary settlement stage for settlement, and is removed from the plant during primary settlement stage desludging.

g. Electrical Items

Before working on either the blower or the optional final effluent pump station the mains supply must be isolated.

The blower is supplied with power through a single phase plug.

'Disconnect the mains supply before removing the cover'.

The blower is arranged to run continuously. The optional final effluent Lift Pump is arranged to have constant power supply, however the pump itself will be activated through the integral float-switch. An optional Warning Beacon can be supplied for remote sitting.

Installation Instructions

IMPORTANT! PLEASE READ HEALTH AND SAFETY INSTRUCTIONS BEFORE ATTEMPTING ANY WORK.

The following instructions are offered for guidance only. We can accept no responsibility for incorrect off loading or installation.

General

Before installing the tank, care has to be given on how to provide adequate ventilation across the plant. As each site is different we can offer the following advice as guidance only.

Ensure that an existing vent stack is in place or is supplied to the building serving the treatment plant. Further, provide an air inlet by connecting a local low-level vent (cowl) to the 110mm spigot on the side of the tank turret. This will ensure aerobic conditions for the micro organisms within the biozone.

The blower needs a supply of fresh air to keep oxygen levels high in the biozone. The optional remote blower is fed with air through the ventilation slots in the kiosk.

In addition, care has to be given on selecting the right location for the treatment plant and how the final effluent is discharged.

The contractor is responsible for off loading all items of equipment with due regard to the following:

- **DO NOT** lift the tank if it contains water.
- **DO NOT** subject the unit to sharp impacts.

WARNING: The lifting procedures outlined below have been developed to ensure the safe handling of the unit. Failure to comply may result in damage to the unit and/or injury to site personnel. When working in a deep excavation, ensure all necessary safety precautions are taken to provide safe working conditions for site personnel. The only time anyone needs to be working at the bottom of the excavation is when levelling the base and ensuring that the first back-fill is correctly placed.

- **ALWAYS** use the lifting eyes on the top of the unit when lifting the plant.
- **NEVER** attempt to lift the unit by attaching lifting gear to the inlet/outlet pipe.
- **NEVER** wholly fill the sump with water before surrounding it in concrete.
- **NEVER** partly or wholly surround the sump with concrete before filling it with water.

NOTE: Do not use vibrating pokers to compact the concrete. Facility must be provided for cable entry into the unit, through the side of the access turret. The electrician responsible for the wiring should be consulted, to ensure a correctly sized duct is provided.

NOTE: The installer is responsible for determining the concrete thickness and strength required for the actual ground conditions, taking into account the buoyancy of the unit when being de-sludged, external forces exerted by the water table, back-fill, traffic loads etc.

The installation should be carried out in accordance with the requirements of the Construction and Building Regulations. During the course of the installation, the following minimum equipment will be required:

- Normal construction equipment and plant.
- Concrete to 20 Newton/mm and 30–50 mm slump. (initially 100 mm)
- Rivets and waterproof mastic for sealing the turret to the sump
- An adequate supply of fresh water to fill the sump at the same rate as backfilling.
- De-watering equipment as necessary.
- Lifting straps or ropes of the correct length and adequate S.W.L.

Deep Invert Units

For all DEEP INVERT and VERY DEEP INVERT units please contact Premier Tech Water & Environment for installation and on site assembly instructions.

Tank Installation

The following instructions are offered for guidance only. It remains the responsibility of the contractor to ensure the correct installation of the plant.

Excavate to the tank dimensions allowing a minimum clearance of 200 mm to the sides of the excavation. Excavate to the appropriate depth for the installation i.e. invert level of incoming drain PLUS the depth of tank to invert of inlet pipe connection PLUS 200 mm minimum concrete thickness (actual thickness to suit ground conditions).

Lay and level a concrete base for the tank to a minimum of 200 mm thickness. (Concrete base to be designed to suit ground conditions)

Lift into position using slings (not supplied), taking care not to damage any internal or external pipework. Check for correct orientation of the inlet and outlet pipework. Check that the unit is level in all directions. It is critical that the SAF tank is installed level to tolerance, failure to do so may result in extended commissioning times or it being impossible to commission the plant. CPL engineering requires the following level tolerance be achieved on the SAF and recorded:

1) Transverse level (across the tank diameter) tolerance of each Tank

2) Axial level (along the tank length) tolerance of each Tank.

Fill the unit with fresh water to a depth of approximately 1m. Commence back-filling with concrete ensuring that the first pour has a slump of approx. 100 mm such that the concrete flows underneath the unit and fills all voids (do not use vibrating pokers).

Continue back-filling in 500 mm lifts, and at the same time, fill the sump with water ensuring that the progressive water level is approx. 500 mm higher than the concrete.

The concrete must be evenly distributed around the unit, ensuring pipe connections are not covered at this stage.

Ensure all pipe connections are made, continue to pour concrete in order to provide a minimum of 100mm thickness over the entire unit.

No superimposed loads should be allowed to be transmitted to the tank shell or turrets.

Electrical Installation.

(Refer to Electrical Drawing in Appendix E)

It is not possible to state a specific installation configuration that would suit all sites. To ensure a safe and cost effective installation, the selection of current protection devices must remain the responsibility of the installer as the person best qualified to assess site

conditions and supply configuration. It is therefore imperative that electrical installation of this equipment is entrusted to a fully qualified electrician.

When installing the electrical supply the following points should be considered:

- 1.The supply to the unit should be provided through a dedicated circuit via isolation and protection devices consistent with the requirements for fixed equipment and in accordance with the latest regulations issued by the Institute of Electrical Engineers;
- 2.The supply to the unit should be fed through a dedicated MCB. Units fitted with the optional Final Effluent Pump Station use an additional feed to the pump isolator. In particular, Earth Leakage Devices provided for normal domestic protection must not form part of the supply circuit to this unit;

Failure to comply with the following could result in the invalidation of warranty:

- 3.All connections made to the junction enclosure should be via correctly sized and rated glands;
- 4.Check all power terminations for tightness prior to commissioning. Loose connections will cause localised overheating with the possibility of fire. (Electrical connections can loosen in transit or through fixing methods used during installation).
- 5.The control kiosk should be sited within 10 meters of the unit. Suitably sized cable protected in a cable duct or suitably sized steel-armoured cable should be used to run between the kiosk and the supply point. All glands used in the kiosk, must be weatherproof.

Air Distribution Adjustment

The air distribution within the bio-zone is sensitive to the distribution manifold being installed level. Ideally equal quantities of air should come from each of the four distribution points, this can be judged quite effectively by observing the streams of bubbles from ground level above the biozone.

Where bubbles are relatively scarce the pipe needs to be raised, and conversely lowered where bubbles are excessive. This is a trial and error process on the initial installation and thereafter adjustments should be rare.

The whole manifold assembly can be withdrawn from the unit, after disconnecting the air supply hose, and adjustments take place at ground level. The assembly is then lowered into the biozone and the process repeated.

Airlifts

Principle of operation

An airlift works by aerating the liquid in a tube and causing this mixture to be less dense than the surrounding water. Thus the aerated liquor moves up the tube by the pressure of the surrounding non-aerated water which forces it to rise. There is a limit to which an airlift will be effective.

Forward feed

The forward feed should **Not** be set to operate for too long otherwise it can hydraulically overload the design of the plant. A nominal setting for each plant should be 3 to 4 minutes every hour. The forward feed provides a balancing function, lowering the primary tank so that peak flows to the bio-zone are smoothed out. For forward feed timer valve settings, see table below.

Humus return

The humus or final settling tanks have material that needs settling as part of the biological process of the treatment of wastewater. The spent biomass needs to be returned to the primary tank for co-settlement. For humus return timer valve settings, see table below.

Settings.

The forward feed and humus returns need to set up for each plant see table below:

	Duration	Frequency
Forward feed	30 seconds	18 min
Humus return	30 seconds	60 min

Plant Start-up / Shutdown Procedures

Start-up and Commissioning.

The unit should be commissioned before sewage is allowed to enter the system.

Electrical connections and cabling should be checked by a qualified electrician.

Check that the overload setting on the starter has the correct value, as shown in the SPECIFICATIONS section of this manual.

Fill the unit with clean water until there is a discharge from the outlet. This is best done by using a hosepipe in the inlet manhole or by running several taps in the connected household(s).

Switch on the main power supply to the Blower, the Blower should run continuously.

Continue filling with water until a continuous flow discharges from the outlet.

Checked by.....Signature.....

The Treatment Plant is now operational. However, the process relies on the growth of micro organisms in the Biological Zone. The time taken for these naturally occurring organisms to develop is dependant on temperature and is typically 6 – 8 weeks. However this may be up to six months in winter. When the biology has 'matured' in this way, the treatment process will be completely established. During this time, do not allow any strong cleaning agents or bleaches to enter the system.

Shutdown Procedure

Temporary absence of flow will not be detrimental as the Blower will continue to recycle flows within the system. However, in circumstances where the flow may be interrupted for more than 2 MONTHS, the plant should be shutdown by the following procedure:

1. De-sludge the system in accordance with the instructions in the MAINTENANCE SCHEDULE section of this manual.
2. Refill the system with clean water as described above.
3. Switch off the mains supply.

Maintenance Schedule

IMPORTANT! PLEASE READ HEALTH AND SAFETY INSTRUCTIONS BEFORE ATTEMPTING TO WORK ON THE SYSTEM.

Primary Tank De-sludging.

NOTE : This operation is required at different intervals depending upon specific site conditions and effluent discharge standards. The recommended interval between de-sludging of the primary tank is shown on table page 5.

De-sludge the Primary stage using a conventional suction tanker (see Appendix C for further details).

Remove the manhole covers from the tank. Ensure that all openings are adequately guarded. Insert the suction hose from the tanker into the compartments of the primary stage and remove all the contents. After desludging, it is **ESSENTIAL** that the **Primary tank** are refilled with Clean Water, as quickly as possible.

Humus tank De-sludging

NOTE : This operation is only required during a plant shut down procedure.

De-sludge the Primary stage using a conventional suction tanker (see Appendix C for further details).

Remove the manhole covers from the tank. Ensure that all openings are adequately guarded. Insert the suction hose from the tanker into the compartments of the primary stage and remove all the contents. After desludging, it is **ESSENTIAL** that the **Primary tank** are refilled with Clean Water, as quickly as possible.

Operation Inspections

Weekly

- Check the operation of the Blower. Remove the manhole cover over the central bio-zone and confirm that aerated liquor is being circulated through the media pack. This will be noticed by air bubbles rising in the biozone. If the air distribution is uneven

then the air manifold needs to be levelled (see Air Distribution Adjustment in the Installation Section)

- Check and confirm that there are no leaks from the exposed pipework.
- Check the final effluent discharging from the unit. If it is cloudy or contains suspended particles, check the humus return is functional.

Six Monthly

- Switch off the power supply and padlock the mains isolator.
- Inspect and clean the air distribution manifold, clean and if necessary replace the blower air filter.
- Ensure that the water level in the biozone is above weir level (desludge tube) before resuming operation and switching the blower on.
- Switch the Isolator to the ON position to resume operation. Ensure that there are no leaks from the delivery pipework.

Periodically

- Primary tank desludging as detailed on table page 5.

Appendix A: Fault Finding

Symptom – Absence of Bubbles in the Biozone

CAUSES	REMEDY
Blower tripped due to:	
1. Power Cut	Do nothing. When power is restored, the system will restart automatically.
2. Supply	Switch off the power. Switch on, and the system should restart automatically. If it does not, switch off the power and call a qualified electrician.

Symptom – Wastewater is backing up (only for integral final effluent pump station)

CAUSES	REMEDY
Final Effluent Lift Pump tripped due to:	
1. Pump Strainer Blocked	Remove the pump and clean the strainer as outlined in the Maintenance Schedule . Reset the overload by pushing the reset button inside the starter and switch on. If the overload trips again, there is a fault with the pump and/or the wiring. Contact your supplier or a qualified electrician.
2. Pump Impeller Jammed	Remove the pump as outlined in the Maintenance Schedule and remove the obstruction. Reset the overload by pushing the reset button and switch on. If the overload trips again, there is a problem with the pump and/or wiring. Contact your supplier or a qualified electrician.
3. Power Cut	Do nothing. When power is restored, the system will restart automatically.
4. Supply (MCB tripped)	Switch off the power and reset the MCB. Switch on, and the system should restart automatically. If it does not, switch off the power and call a qualified electrician.

Appendix B: Equipment Specification

Tank

Material Specification:	Glass Reinforced Polyester Resin with interior and exterior Gel Coat - 1: 2.5 Glass/Resin Ratio.
Colour:	Grey

Kiosk

Material:		Fabricated steel powder coated (Green)
Protection:		IP65
Dimensions: (max)	SAF 30, 35, 40 SAF50	705mm x 505mm x 750mm (w x d x h) 750mm x 405mm x 1250mm (w x d x h)

Blower for SAF 030

Material Specification:	2 Number Secoh JDK-S-250
Outlet Connection:	26mm od
Voltage:	230v / 1 phase / 50 Hz
Rated Power:	2 x 0.225kW

Blower for SAF 35 & 40

Material Specification:	2 Number Secoh JDK-S-250
Outlet Connection:	26mm od
Voltage:	230v / 1 phase / 50 Hz
Rated Power:	2 x 0.225kW

Blower for SAF50

Material Specification:	1 x SV 200/2 Becker
Outlet Connection:	G 2" threaded
Net Weight:	26kg
Voltage:	220/240v / 1 phase / 50 Hz
Rated Power:	1.1kW

Appendix C: De-sludging Instructions

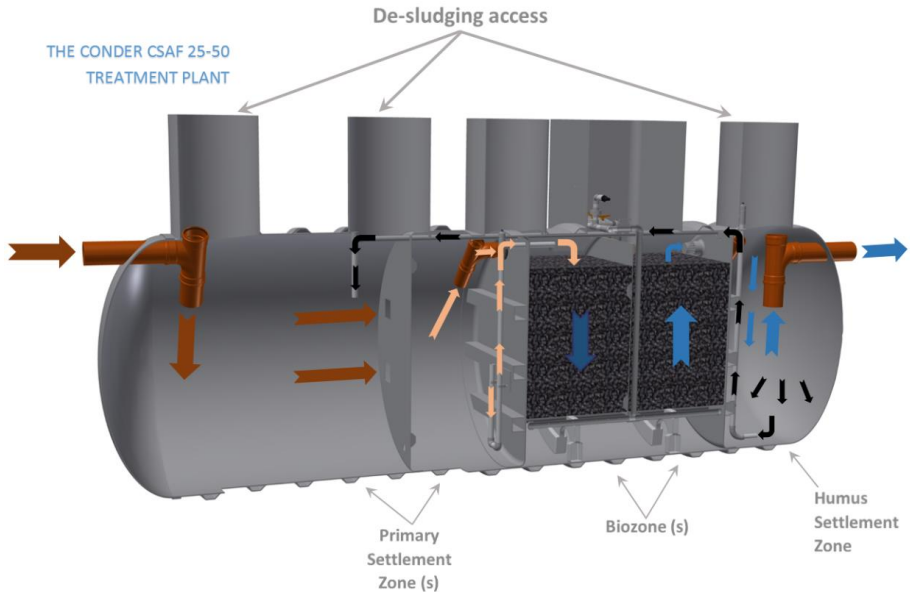

Notes:

1. empty the first stage of the primary settlement tank completely
2. empty the humus tank section with tanker

Please note that it is ESSENTIAL to refill the primary tank with clean water as quickly as possible after de-sludging.

Note: A log must be kept recording the frequency of emptying and the service provider. Any non-conformance or issues encountered during de-sludging operations should also be recorded in this log. Failure to maintain an adequate log of both the service history and de-sludging operation will invalidate the plant warranty.

Note: The waste should be removed under the terms of The Waste Management Code of Practice. The Code imposes a duty of care on the waste producer to ensure that the Cleansing contractor is registered with the Environment Regulator and that the final disposal of the waste is to a licensed facility.

Appendix D: Dimensions and Mechanical Installation

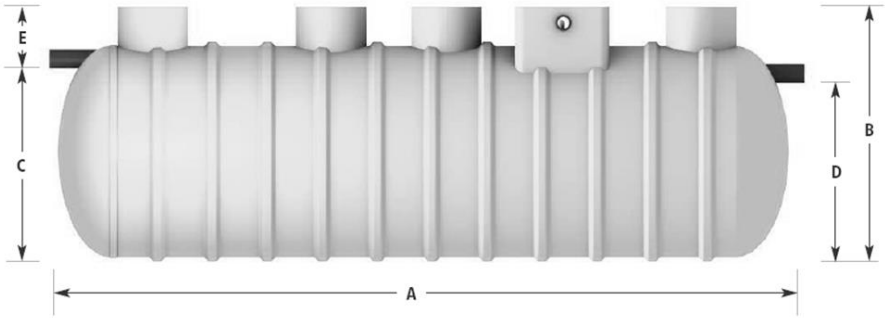

PRODUCT REFERENCE (PE)	GROSS CAPACITY (L)	TANK DIA (mm)	INLET/ OUTLET PIPE DIA (mm)	A (mm)	B (mm)	C (mm)	D (mm)	E (mm) STANDARD INVERT DEPTH	EMPTY WEIGHT (Approx in tonnes)
CSAF030	11400	1.8	160	4590	2625	1625	1500	1000	1.2
CSAF035	13000	1.8	160	5200	2625	1625	1500	1000	1.3
CSAF040	16800	1.8	160	5900	2625	1625	1500	1000	1.4
CSAF050	18300	1.8	160	7300	2625	1625	1500	1000	1.6

Deeper inverts can be accommodated with extension shafts.

Unitank SAF System

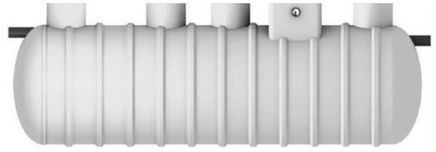

Product Reference	Population Equivalent	Dry Weather Flow (DWF) M ³ /d	Peak Flow Max for 10min (l/s)	BOD kg	NH ₃ kg	Minimum Desludge Period
CSAF 30N20	30	6	0.21	1.8	0.24	120
CSAF 35N20	35	7	0.24	2.1	0.28	120
CSAF 40N20	40	8	0.28	2.4	0.32	120
CSAF 50N20	50	10	0.35	3	0.4	120

Discharge Standard (95% ile):

20 mg/l BOD₅

30 mg/l SS (suspended solids)

20 mg/l NH₃-N



Forward Feed and Humus
Return Airlift Timer Valve

10mm Forward Feed and
Humus return airlift air
pipework connections to
blower (push fit connectors)

Blower discharge pipework
to plant (through duct)

Generic Installed Kiosk



Timer Valves

Plan View of CSAF

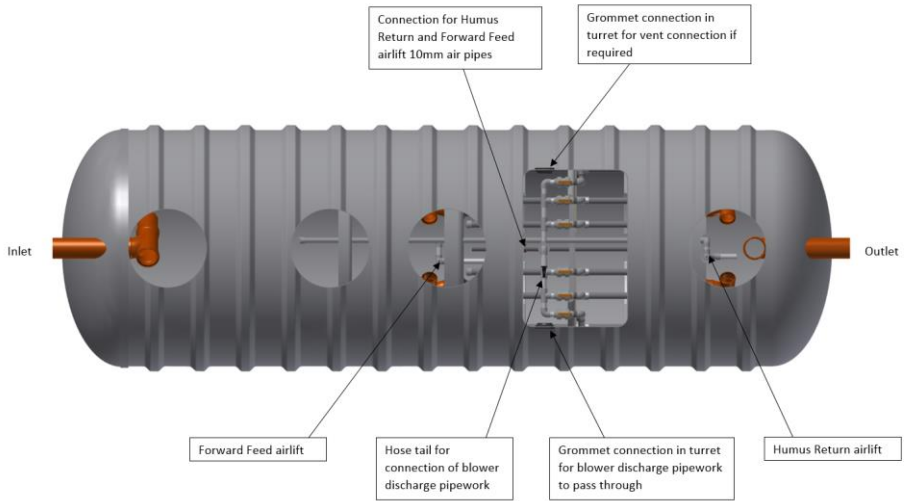

Detail Showing Airlift Connection Points and Aeration Header

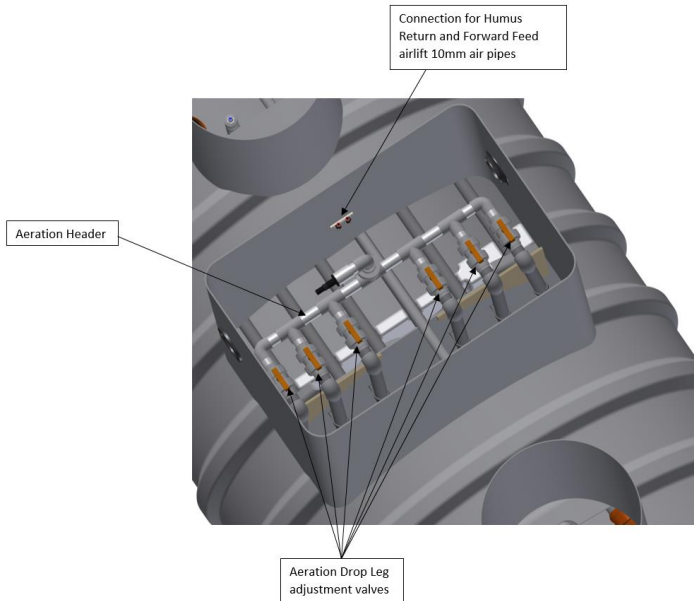

Appendix E: Kiosk & Electrical Drawing

Part Number: **SAF1026K-A**

Description: **Weather Proof Sewage Treatment Plant Mild Steel Kiosk**

Applications:		
N20 Range	N10 Range	N05 Range
SAF025/030		



Indicative kiosk photo

Options			
	Type	Qty	Voltage
Sound Attenuation	Optional		N/A
Final Effluent Pump			
GSM Unit			
Humus Return			
Cooling Fans			

Kiosk Sizes:

Width	750mm
Depth	505mm
Height	750mm

Kiosk Material:

Painted Mild Steel

Nominal Air output

26 m³/h@165 mbar

Blower 1:

Model	JDK-200	No of outlets	1
Motor Size	0.21kW	No of timer valves	2

Blower 2:

Model	JDK-200	No of outlets	
Motor Size	0.21 kW	No of timer valves	

Total Installed Power

0.42 kW 1 phase

Unit Weight

70 kg

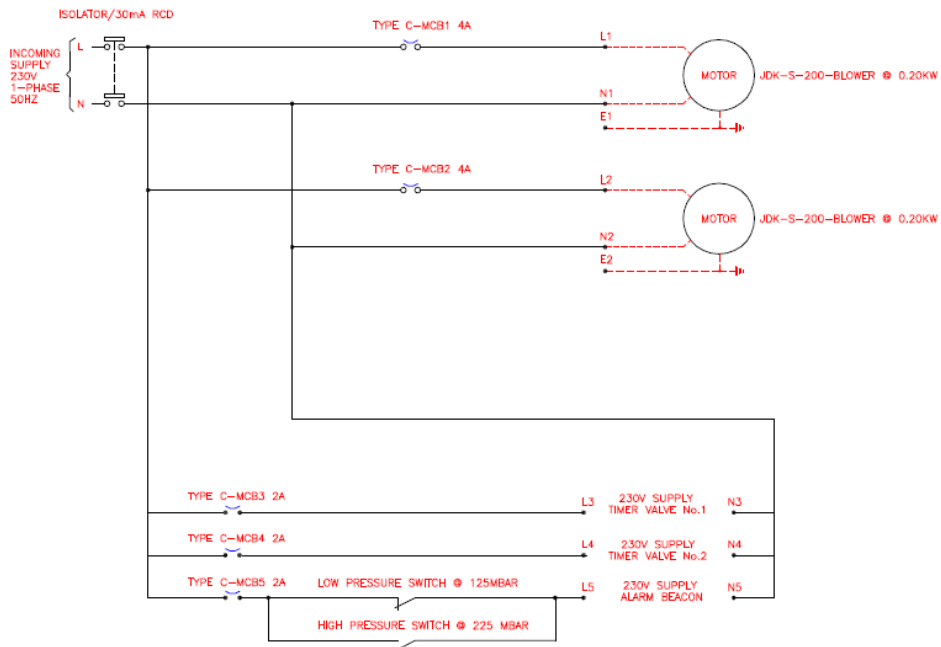

UNIT 1A, REKENDYKE INDUSTRIAL ESTATE
SOUTH SHIELD'S, TYNE AND WEAR, NE33 5BZ
TEL: 0191 4540230
FAX: 0560 2093916
WEB: WWW.SCHOFIELDELECTRICALS.CO.UK

1ST ISSUE	JDS	SGH	07.05.15
REVISION	DRAWN BY	CHECKED BY	DATE
SAF 1026A-0000			
WIRING DIAGRAM			
SHEET 1 OF 1			

Part Number: **SAF1030K-A**

Description: **Weather Proof Sewage Treatment Plant Mild Steel Kiosk**

Applications:		
N20 Range	N10 Range	N05 Range
SAF035/040		



Indicative kiosk photo

	Options			
	Type	Qty	Motor size	Voltage
Sound Attenuation	Optional		N/A	N/A
Final Effluent Pump				
GSM Unit				
Humus Return				
Cooling Fans				

Kiosk Sizes:

Width	705mm
Depth	505mm
Height	750mm

Kiosk Material:

Painted Mild Steel

Nominal Air output

30 m³/h @ 165 mbar

Blower 1:

Model	JDK-250	No of outlets	1
Motor Size	0.24 kW	No of timer valves	2

Blower 2:

Model	JDK-250	No of outlets	2
Motor Size	0.24 kW	No of timer valves	

Total Installed Power

0.48 kW 1 phase

Unit Weight

75 kg

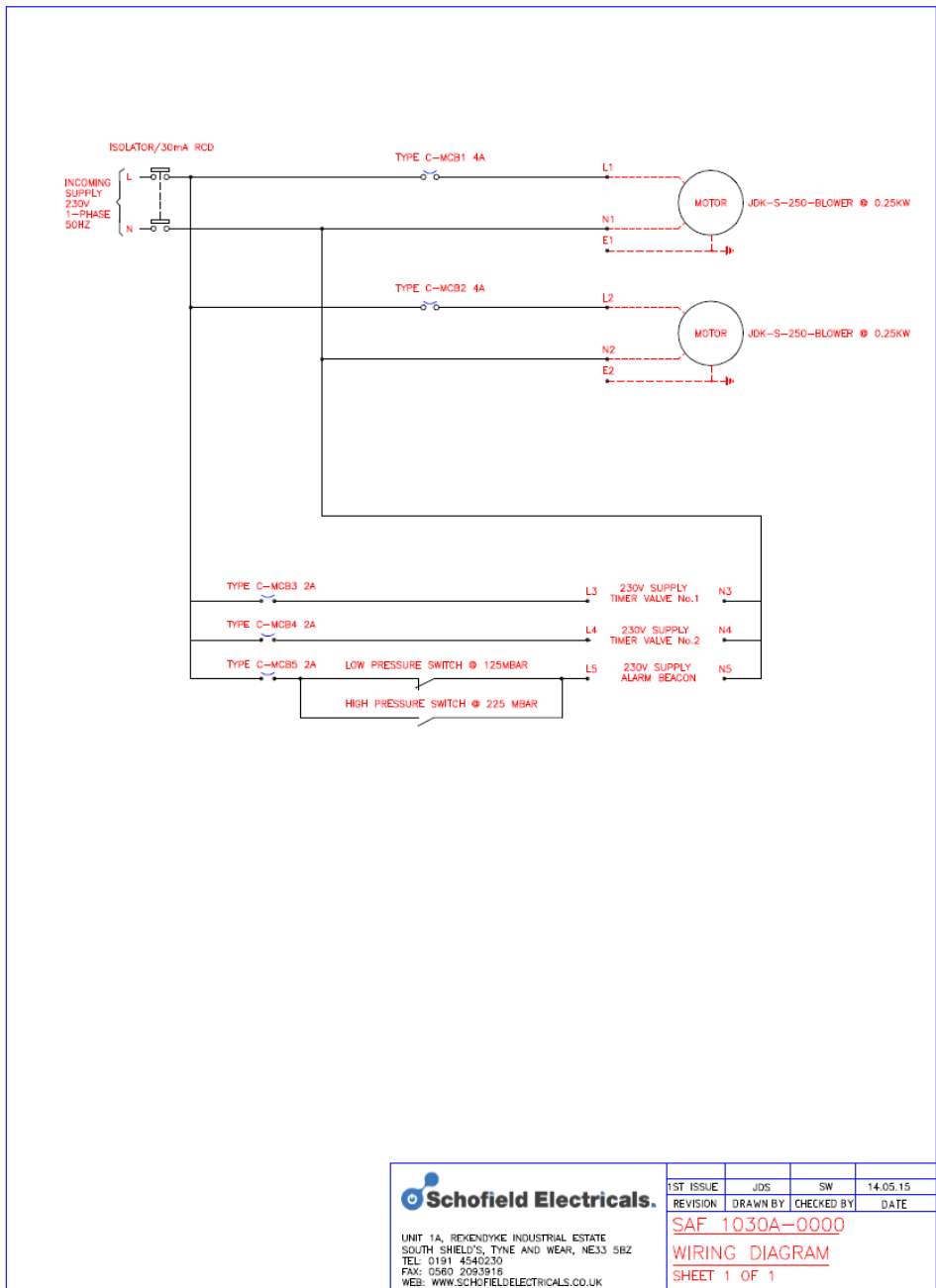

	1ST ISSUE	JDS	SW	14.05.15
	REVISION	DRAWN BY	CHECKED BY	DATE
<p>UNIT 1A, REKENDYKE INDUSTRIAL ESTATE SOUTH SHIELDS, TYNE AND WEAR, NE33 5BZ TEL: 0191 4540230 FAX: 0560 2093916 WEB: WWW.SCHOFIELDELECTICALS.CO.UK</p>				
<p>SAF 1030A-0000</p> <p>WIRING DIAGRAM</p> <p>SHEET 1 OF 1</p>				

Part Number: CSAF-1048A

Description: Weather Proof Sewage Treatment Plant Mild Steel Kiosk

Applications:		
N20 Range	N10 Range	N05 Range
CSAF050		



Indicative kiosk photo

Options				
	Type	Qty	Motor size	Voltage
Sound Attenuation	Optional		N/A	N/A
Final Effluent Pump				
GSM Unit				
Humus Return				
Cooling Fans				

Kiosk Sizes:

Width	750mm
Depth	405mm
Height	1250mm

Kiosk Material:

Painted Mild Steel

Nominal Air output

48 m³/h @ 175 mbar

Blower 1:

Model	SV-200/2/1.1KW	No of outlets	1
Motor Size	1.1 kW	No of timer valves	2

Total Installed Power

1.1 kW 1 phase

Unit Weight

95 kg

Key Features:

- Thermostatic control. Automatic blower shutdown when maximum operating temperature is reached and automatic restart when kiosk cools sufficiently.
- Automatic blower shutdown and the alarm beacon flashes when a high pressure is detected (requires inspection and remedy).
- The air filter has a pressure switch to monitor the pressure drop across the filter, if it goes above 30mbar, which would indicate a dirty filter, then the blower automatically shuts down and the alarm beacon flashes (requires inspection and remedy)
- Integral pressure gauge to monitor blower operating pressure.

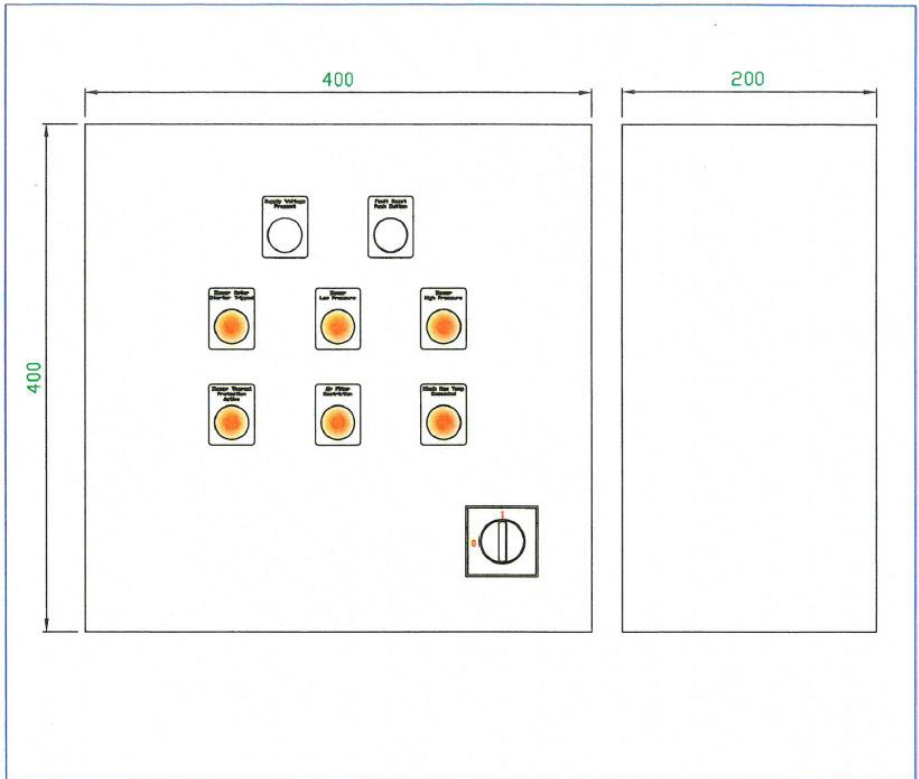

TERMINAL DESCRIPTIONS FOR KIOSK EQUIPMENT AND EXTERNAL CONNECTIONS.

⊕ ⊖	⊕ ⊖	⊕ ⊖	⊕ ⊖	⊕ ⊖	⊕ ⊖	⊕ ⊖	⊕ ⊖	⊕ ⊖	⊕ ⊖	⊕ ⊖	⊕ ⊖							
A1	N1	E1	A2	N2	E2	A3	N3	E3	T1	T2	L	E3	L	L	N	N	99	E3
⊕ ⊖	⊕ ⊖	⊕ ⊖	⊕ ⊖	⊕ ⊖	⊕ ⊖	⊕ ⊖	⊕ ⊖	⊕ ⊖	⊕ ⊖	⊕ ⊖	⊕ ⊖	⊕ ⊖	⊕ ⊖	⊕ ⊖	⊕ ⊖	⊕ ⊖	⊕ ⊖	⊕ ⊖
BLOWER			TIMER VALVE 1			TIMER VALVE 2			TH1	TH2	KLIXON THERMAL TRIP	CONTROL COMMON LIVE	CONTROL COMMON NEUTRAL	ALARM BEACON				

- MINIMUM POWER WIRING TO BE 15MM.
- MINIMUM CONTROL WIRING TO BE 0.75MM.
- POWER CABLES TO BE FITTED WITH CORD TERMINALS OR LUGS DEPENDING ON SIZE AND TYPE OF TERMINATION.
- CONTROL TERMINALS TO BE FITTED WITH CORD TERMINALS, PIN OR FORK DEPENDING UPON THE TYPE OF CONNECTION.
- ALL CABLES UP TO 16MM TO BE COLOUR CODED AS:
400 VOLTS L1,L2,L3 -BROWN, BLACK AND GREY
230 VOLTS NEUTRAL -BLUE
LOW VOLTAGE AC -WHITE
EXTRA LOW VOLTAGE DC -VIOLET
POTENTIAL FREE -PINK
- ALL CABLES ABOVE 16MM TO BE BLACK WITH THE END HEAT SHRUNK, COLOUR CODED WITH PHASE IDENTIFICATION.
- ALL CONTROL CABLES TO BE IDENTIFIED AT EACH END BY THE USE OF COLOUR CODED FERRULES.
- WHEN A CABLE CONNECTS TO AN OUT GOING TERMINAL, THE NUMBER IS THE SAME AS THE TERMINAL NUMBER.

GENERAL LAYOUT, TERMINAL DESCRIPTIONS AND WIRING NOTES

TH1 = CUT OFF THERMOSTAT SET AT 40 DEG
TH2 = RESET THERMOSTAT SET AT 35 DEG



UNIT 1A, REKENDYKE INDUSTRIAL ESTATE
SOUTH SHIELDS, TYNE AND WEAR, NE33 5BZ
TEL: 0191 454030
FAX: 0191 454031
WEB: WWW.SCHOFIELDELECTRICALS.CO.UK

1ST ISSUE	JDS	CG	AUG 16
REVISION	DRAWN BY	CHECKED BY	DATE
CSAF-1048-A			
ELECTRICAL CONTROL PANEL			
PREM TECH KIOSK REF: 170898			

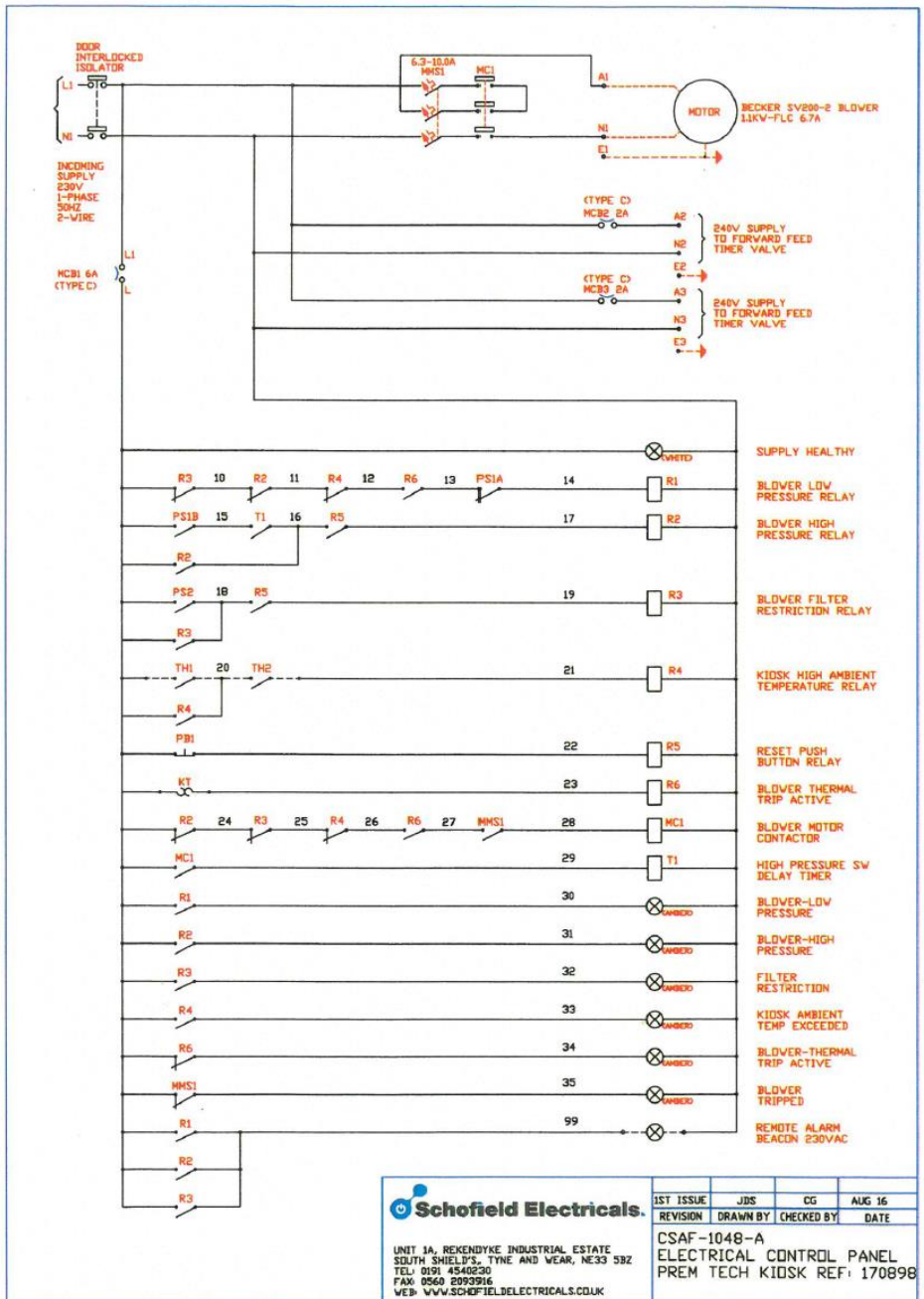









Schofield Electricals

UNIT 1A, REKENDYKE INDUSTRIAL ESTATE
 SOUTH SHIELD'S, TYNE AND WEAR, NE33 5BZ
 TEL: 0191 4540230
 FAX: 0191 2092916
 WEB: WWW.SCHOFIELDELECTRICALS.CO.UK

1ST ISSUE	JDS	CG	AUG 16
REVISION	DRAWN BY	CHECKED BY	DATE

CSAF-1048-A
 ELECTRICAL CONTROL PANEL
 PREM TECH KIOSK REF: 170898

PANEL INDICATION/FAULT FINDING GUIDE

<p>Supply Voltage Present</p> 	<p>The supply healthy light indicates that there is voltage present in the control panel.</p> <p>If this indicator is not lit check your supply to the kiosk or consult a qualified electrician.</p>
<p>Blower Motor Starter Tripped</p> 	<p>The blower tripped light indicates that there has been a short circuit or an overload in the blower electrical circuit. the trip can be reset within the control panel.</p> <p>It is recommended that if this lamp is illuminated and the blower will not restart after the trip has been reset, you should consult a qualified service engineer/electrician.</p>
<p>Blower Low Pressure</p> 	<p>The blower low pressure light, indicates that there is a pressure loss from the blower pipe work. check the pipe connections are secure and for any signs of air leaking. an abnormal low level in the tank may also cause this signal.</p> <p>The blower pressure can be verified by the pressure gauge, the low pressure signal will illuminate at a pressure of 150mbar or below.</p> <p>If the levels in the tank are particularly low, this also may cause the low pressure light to illuminate.</p>
<p>Blower High Pressure</p> 	<p>The blower high pressure light, indicates that there is an air flow restriction within the blower pipe work.</p> <p>check the pipe work for any signs of damage or crushing, check that the air diffuser valves have not been shut off.</p> <p>Once the checks have been completed and the problem rectified, the reset button may be pressed, the blower will re-start. If the problem is still present then the blower will stop and the signal will illuminate again.</p>
<p>Air Filter Restriction</p> 	<p>The blower 'Air Filter Restriction' light, indicates that there is a restriction within the blower air filter.</p> <p>Remove the filter and check the condition, clean the existing filter and replace or replace with a new filter. check for any debris around the filter intake and remove/clean if necessary.</p> <p>Once the filter has been cleaned/replaced, the reset button may be pressed and the blower will re-start. If the problem is still present then the blower will stop and the signal will illuminate again.</p>
<p>Kiosk Max Temp Exceeded</p> 	<p>The kiosk max ambient temp light, indicates that the internal temperature of the kiosk has exceeded the recommended operation temperature of the blower. The system will shut down the blower until the temperature returns to an acceptable level.</p> <p>Once this occurs the blower will restart automatically and continue to operate as normal. (this is part of the normal operation for the plant)</p> <p>Check that the louvre vents on the kiosk are not blocked or restricted so as air can flow freely inside the kiosk.</p>
<p>Blower Motor Thermal Protection Active</p> 	<p>The Blower Motor thermal protection light indicates that the motor temperature has exceeded its designed working parameter. this is part of the motor protection circuit and will self reset and restart, once the motor has cooled down.</p> <p>It is recommended that if this lamp is illuminated and the blower will not restart after the motor has cooled, you should consult a qualified service engineer/electrician.</p>
<p>Fault Reset Push Button</p> 	<p>If there has been a high pressure, or filter restriction fault, the reset button will need to be pressed once the fault has been rectified.</p>



Warranty Activation Form

Thank you for choosing Premier Tech Water & Environment. Your product must be registered to activate the standard warranty and any extended warranty offered on certain product ranges.

Products installed to protect the environment and avoid EA prosecution must be maintained and serviced regularly to ensure that they operate efficiently and effectively. Premier Tech Water & Environment has a nationwide network of service partners that can offer complete service and maintenance packages for peace of mind.

Our service partners can also commission your products should you wish.

In order to activate your extended warranty and a free post installation check, please use one of the following options:



Complete, print and return this form to:

Premier Tech Water and Environment Ltd

2 Whitehouse Way, South West Industrial Estate, Peterlee, Co Durham, SR8 2RA, UK

Name

Address

Postcode

Telephone Number

Email Address

Site Address (if different)

Product Purchased

Reference Number (if known)

Where Purchased

Proof of Purchase

Please contact me regarding:

Commissioning quotations

Service and maintenance quotations

