



# INSTRUCTION MANUAL FOR ELECTROMAGNETIC AIR PUMP

MODEL : JDK-60

JDK-80

JDK-100

JDK-120

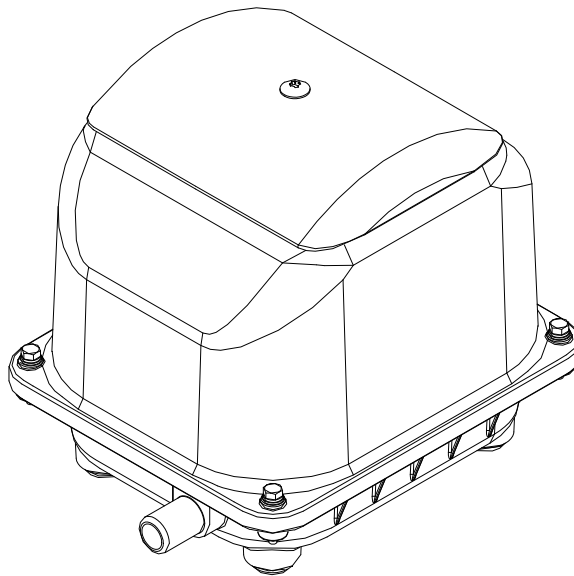

We thank you for purchasing our air pump. Prior to use, it is kindly requested that the instructions in the columns of WARNING in this manual should be read carefully to understand the equipment well. Please keep this manual available in case of need.

**SECOH SHANGHAI MEC LTD.**

# CONTENTS

1.Name of Parts .....	1
2.Instructions	
2-1 Prior To Operation .....	2
2-2 Storage and Transfer .....	3
2-3 Installations	
1) Instructions to Location of the Air pump .....	3
2) Instructions to Electric Installation .....	5
3) Instructions to Mounting .....	5
4) Instructions to Piping .....	6
5) Instructions to Operation .....	6
3.Daily Maintenance .....	7
4.After-Sale Servicing	
4-1 Repair and Its Order .....	8
4-2 Replacement Parts .....	9
5.Specifications .....	10

# 1.Name Of Parts

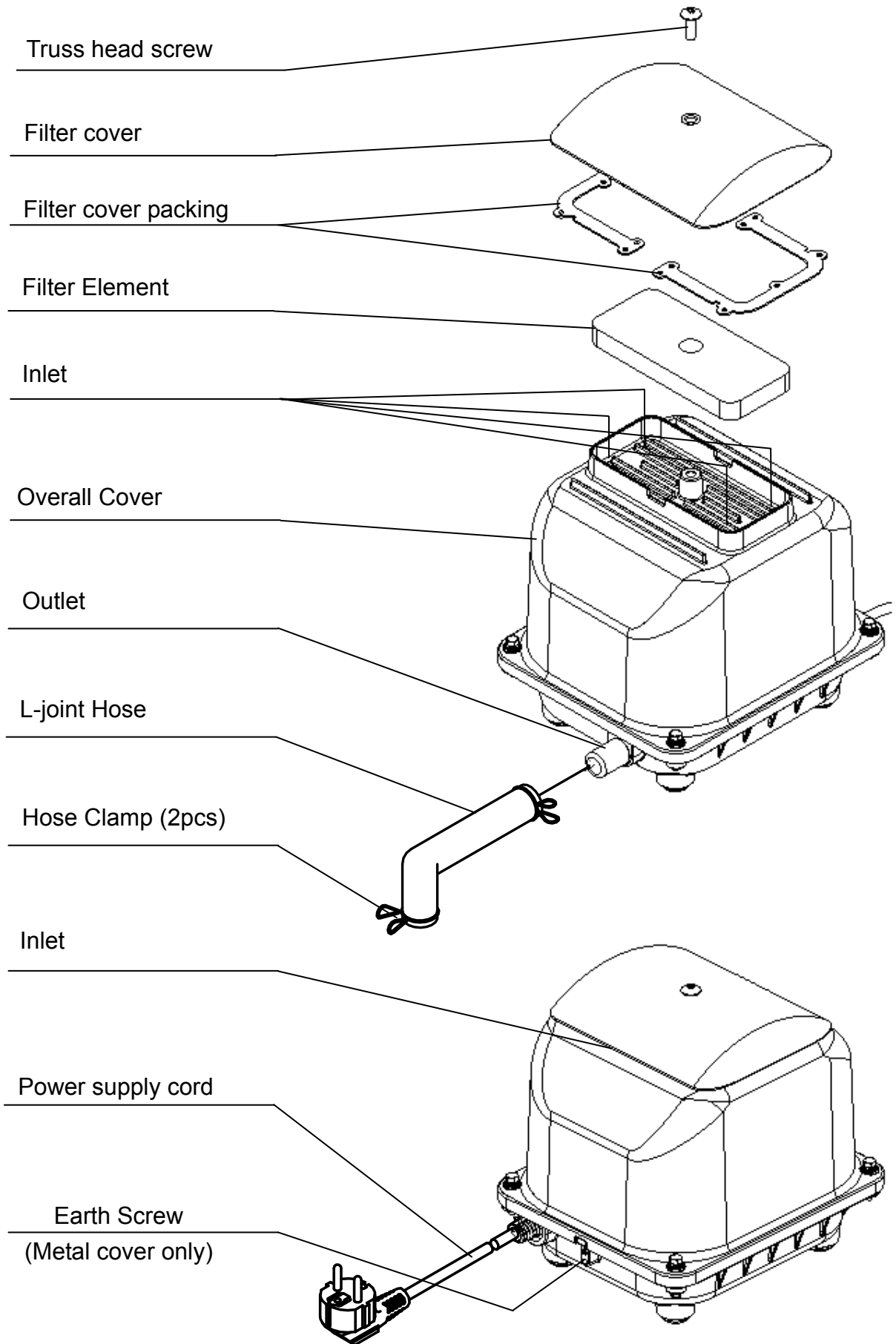

## 2. Instructions

- Prior to operation, read "Instruction" to ensure the air pump is put in operation correctly.
- Be sure to follow the instructions herein described, especially, the following safety instructions.



### **WARNING**

High potential risks resulting from improper handling, as it can cause death or serious injuries.



### **CAUTION**

High potential risks resulting from improper handling, as in some cases it can cause serious injuries.

- Each time after reading this Manual, keep it in a designated place so that the user has access to it at any time.

### 2-1 Prior To Operation



### **CAUTION**

- This air pump is designed only for air feeding.
  - Since the fluid flowed in runs through the part charged, inflow of any flammable gas or liquid could cause ignition or an electric shock or short-circuit.

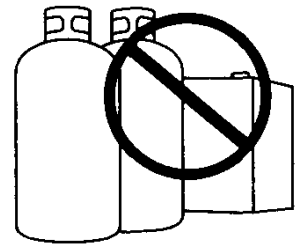

- Check the nameplate attached to the air pump body. And, be sure to use the air pump with the specified power supply only.
  - Use of any power supply other than specified can cause some troubles, including an electric shock and short-circuit.

- This air pump is not designed to be mounted on the vehicle. So, do not install it on the vehicle.

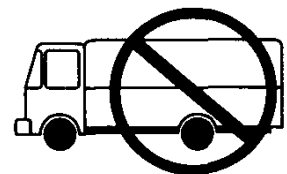

- In applications where the stop of air supply can never be allowed, such as fish raising, a spare air pump should be provided.
  - Make sure to operate the spare air pump every other month to confirm its proper operation.

## 2-2 Storage and Transfer



### CAUTION

- When transferring the air pump. Carry the body by both hands.
  - Do not carry the air pump by holding the filter cover, as the body may slip off the filter cover and may drop on your feet.
  - Do not carry the air pump by holding the power cord, which may cut the wires in it. It may cause heat or ignition. Wear gloves not to be burnt due to the body can heat up during operation.

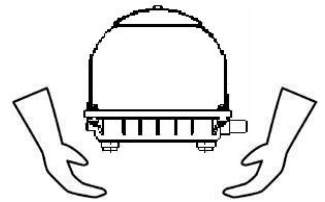

- Do not store the air pump in a place where the ambient Temperature is below  $-10^{\circ}\text{C}$ . The magnet inside the air pump is weakened, and as the result, the equipment will not perform as intended.
- Do not store the air pump in any areas sunlit directly or at high temperature. Rubber parts inside the air pump will have natural deterioration.

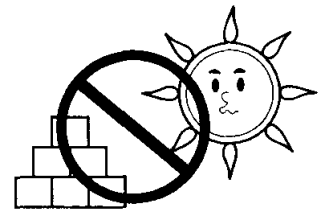
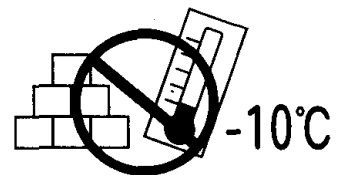

## 2-3 Installations



### WARNING

- Installation of the air pump (including wiring and piping) should be done by our distributor or a specialist.
  - Improper installation done by yourself will cause air leak, electric shock or fire.

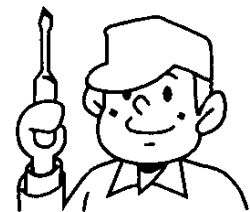

### 1) Instruction to Location of the Air pump



### CAUTION

- Do not install the air pump in a place where it can be submerged by rain or snow.
  - Electric leakage or shock will be caused by water leaked in the charged part of the submerged air pump.

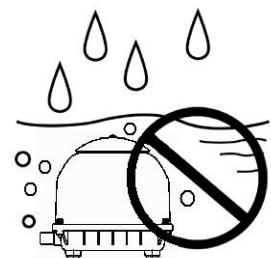



## CAUTION

- Set the air pump above the water level.
  - Setting of the air pump below the water level will cause counterflow of water from siphon phenomenon, when stopping the air pump. Such counterflow of water will cause the part charged to be immersed in water, and result in leakage, electric shock or short circuit.

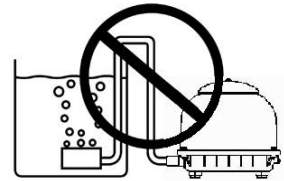

- Do not install the air pump in a place where any flammable gas can be leaked.
  - The ignition could be caused by the accumulation of the leaked gas around the air pump.

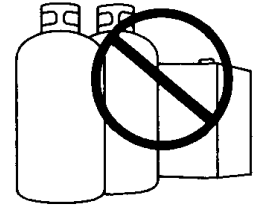

- Set the air pump away from places like bed rooms, reception room, Noise may bother in the quiet nighttime etc
  - At night when the surrounding is quiet, the operating sound may be a nuisance.

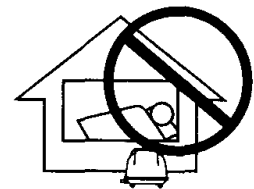

- Set the air pump in the shade and well ventilated place.
  - The lives of the diaphragms and valves in the air pump may be shortened under quite high temperature caused by the heat of the sunlight. When installing the air pump outdoors, be sure to use a waterproof receptacle.
- Do not set the air pump in a humid or dusty place such as drift.
  - The lives of the diaphragms and valves of the air pump may be shortened by the overheat of the air pump due to the less suction air through easily blocked filter element in a dusty place.

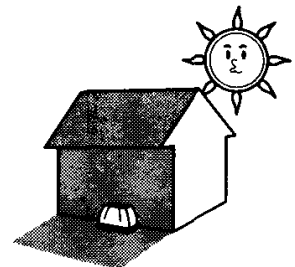

- Set the air pump in a place where working space for maintenance can be secured.

## 2) Instruction to Electric Installation



### CAUTION

- A Breaker with Ground-Fault Protection should be set in the wiring of power supply.
  - No provision of Breaker with Ground-Fault Protection will be cause of electric shock.

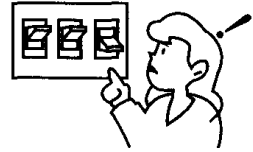

- When installing the air pump outdoors, be sure to use a waterproof receptacle.
  - Exposing of the part changed to rain water will be cause of leakage or electric shock.

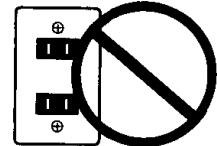

- This product should be grounded with an appropriate grounding wire.
  - Improper grounding or no grounding can result in a risk of electric shock.  
(Apply only to product with metal cover)



## 3) Instruction to Mounting



### CAUTION

- In case of mounting the air pump at a place got wet heavily, provide a roof or a fence to keep the air pump from water.
  - Water of slanting rain etc taken in the air pump will enter the part changed, which can be cause of leakage, electric shock or short circuit.

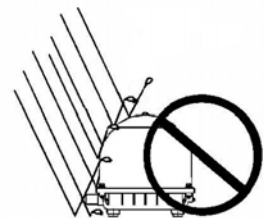

- The exclusive mount for air pump installation made of concrete should be arranged. The mount should be away from the foundation and its height should be min 10cm higher than the foundation.
  - Noise may be caused by vibration of the air pump mounted on an unstable place such as concrete blocks, shelf etc.
- Install the air pump on a horizontal mount taken a level after the concrete has completely set.
  - Setting the air pump before concrete has been completely dry can embed it therein.
  - The load caused by setting the air pump in a position out of the life of the parts.
- A ventilation fan should be put in a fence for water, noise proofing to keep temperature inside the fence below 40°C.

#### 4) Instruction to Piping

- The pipe to discharge air should be hard chloroethylene vinyl pipe VP13 (ID13mm × OD18mm).
- Air piping line should be as short and straight as possible.
  - The total length of air piping should be shorter than 5m approximately. Please consult with us if air piping is longer than 5m.
- Make sure that no particles of soil etc are left in the in the piping under its construction.
  - Extra pressure caused by the piping longer than 5m, piping will be applied on the air pump, which will result in overheat of the air pump. It may shorten the life of diaphragms and valves.
- Connect the air pump to the air piping with an accessory L-joint hose, and secure the connection with a hose band.
  - Adjust the locations of the air pump outlet and air piping so that no forcible loads are applied to the L-joint.

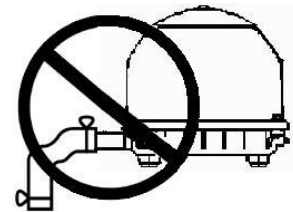
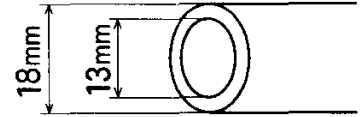

#### 5) Instruction to Operation



### WARNING

- Do not break or work the power cord.
  - Breaking or working of the cord will be cause of electric shock or fire.
  - Heavy loading, heating or pulling will be cause of breakage.
- If the supply cord is damaged, it must be replaced by the manufacturer, its service agent or similarly qualified persons in order to avoid a hazard.

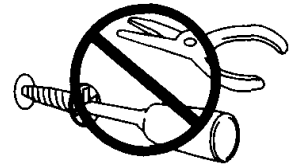

- Clean the dust on electric source plug at least once a year. Plug in completely.
  - Dust on the power plug or incomplete plugging in will be cause of electric shock.

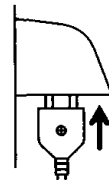

### CAUTION

- Do not touch the cords with wet hand.
  - Touching with wet hand will be cause of electric shock.
- Disconnect all appliances in the aquarium or pond from the supply mains before putting your hands into the water.







## CAUTION

- Pull off the power cord by holding the power plug.
  - Pulling the power cord by itself will cause a part of the core wire to be broken, and lead to heating or ignition.

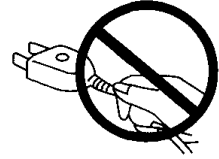

- Do not wash the air pump with water.
  - Washing can be leakage, electric shock or short circuit.

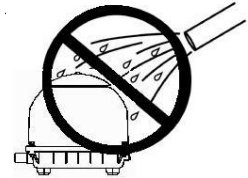

### 3. Daily Maintenance



## CAUTION

- Prior to maintenance servicing, pull off the power cord to stop operation of the air pump.
  - Dust could enter the air pump and cause troubles such as leakage or short circuit.

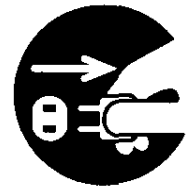

## ● CLEAN THE FILTER ELEMENT QUARTERLY.

- 1) Undo the truss head screw.
- 2) Remove the filter cover by pulling off in the direction shown.
- 3) Take out the filter element, and slap down dust by hand. If it is heavily contaminated, wash it by rubbing using neutral detergent. Then, wash with water and dry it in the shade.
- 4) Please confirm whether there is any sewage or dirt blocking the inlets (4 points). If yes, please clear it up.
- 5) Reassemble the filter element back in place, and press in the filter cover. (into the position shown,)
- 6) Secure the filter cover with truss head screw.

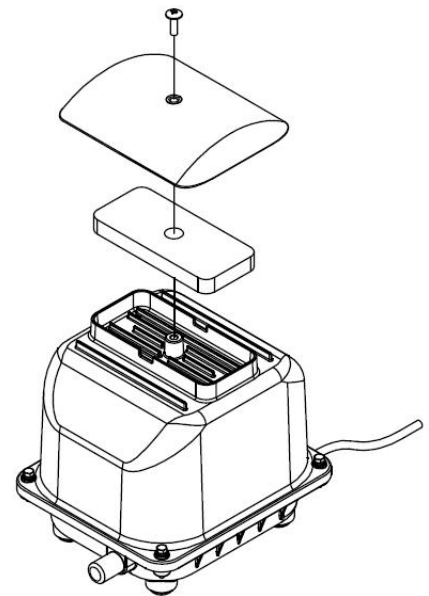

## CAUTION

- Do not wash with water.
- Squeeze the rag thoroughly and wipe it.
- Do not use benzene or thinner, as it can damage coating.

## ● DAILY CHECKS

- Is air blowing out properly?
- Isn't the air pump making abnormal noise or vibrations?
- Is the temperature of the air pump not abnormally high?
- Is the power cord or plug not damaged, swelled or discolored?
  - ※ if any irregularity is found, read REPAIR AND ITS ORDER.

## 4. After-sale Servicing

### 4-1 Repair and its Order

- When "fail" is doubted, read the following and check it again.

Phenomena	Checks
●The air pump does not work.	●Doesn't the power supply give out?
●The discharged air volume decrease. ●Abnormal temperature rise. ●The air pump sometimes operate and sometimes doesn't.	●Is the piping or diffuser pipe not blocked? ●Doesn't the valve in the piping shut? ●Is the filter element not blocked?
●Noise is abnormal.	●Is the air pump not in touch with the surrounding articles?

- If the failure is found even after checking above points, remove the plug to stop operation. Then, call the distributor or service shop with the following information.

Air pump type: Electromagnetic type

Model: JDK-○○ (Refer to name plate attached)

Failure mode: As detailed as possible.



### WARNING

- Do not continue the operation as it runs abnormally.
  - Continue running will cause of leakage, electric shock or short circuit.
- Do not proceed with repairing by yourself.
  - Improper repairing will be cause of leakage, electric shock or short circuit.

- When there is any question about after-sale servicing, please consult with our distributor or service shop, or our customer service office nearby.

## 4-2 Replacement Parts

- Do not use any parts for replacement other than genuine parts.
  - Parts other than genuine parts may have different size, and so the air pump will not only perform as intended but also cause to be broken.
  
- Such parts as in the following replacement parts list will lose their original function by wear out, deterioration etc during operation.

● Diaphragm	● Valve	● Filter
● Connecting pipe	● Vibration isolating rubber	
● Tank base packing	● Rubber bush	● L-joint hose
● Power supply cord		

- In order to ensure long time service of the air pump, it is recommended that diaphragm and valve should be replaced at least once each year.
  
- The replacement parts will be available for seven(7) year after production stop of the pump.

- Customer Service Office -

**[www.secoh-europe.com](http://www.secoh-europe.com)**

Head Office : BIBUS GmbH, Lise-Meitner-Ring 13,  
DE-89231 Neu-Ulm, Germany

Tel: +49-731-20769-0  
Fax: +49-731-20769-620

## 5. Specifications

Model		JDK-60	JDK-80	JDK-100	JDK-120
Rated Voltage	V	220 - 240			
Frequency	Hz	50			
Oper. Press.	kPa	20			
Air capacity	L/min	60	75	95	120
Power	W	38 – 43	50 – 55	75 – 80	90 – 100
Outlet diameter	mm	O.D. 19 (hard vinyl chloride pipe VP13)			
Mass	Kg	Approx. 6.5 (metal) / 5.0 (plastic)			
Standard accessories		L-Joint hose (with hose band)			

※The air capacity power in the specifications shown are typical values in service at operating pressure, and so these are not guaranteed values.

### TO THE CUSTOMER:

Fill in the date purchased as well as the name of distributor or service shop for convenience when ordering repair.

Date purchased	
Name of distributor/ Service shop	Tel.